

Description

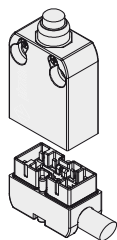

The result of the long-standing expertise of Pizzato Elettrica in the creation of position switches, the NA, NB, NF series achieve the highest standard of flexibility and depth of range present today on the pre-wired switches market. Configurable, adjustable, pivotable and, not least, customisable with special cables or custom wiring - these are features that today make these series unique in the European panorama, ideal for easily providing our customers with customised switches.

Switches with connectors



The new fundamental feature of this series of pre-wired switches is that the switch body and the wired connector are separated.

Using the connector the end-user can replace a product on field without having to disconnect the complete wiring.

Moreover in this way it is easier to combine products with different cable types and lengths.

Head with variable orientation

All heads can be turned in 90° steps. The new head for swivelling levers has been designed with compact dimensions so that it does not protrude over the switch profile. Therefore, it is also possible to install the switches on the wall.

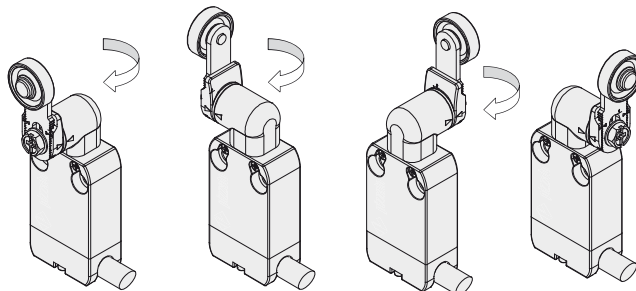

Protection degrees IP67 and IP69K

IP69K
IP67

These devices are designed to be used in the toughest environmental conditions and they pass the IP67 immersion test acc. to EN 60529. They can therefore be used in all environments where maximum protection degree of the housing is required. Due to

their special design, these devices are suitable for use in equipment subjected to cleaning with high pressure hot water jets. These devices meet the IP69K test requirements according to ISO 20653 (water jets with 100 bar and 80°C).

Reversible levers

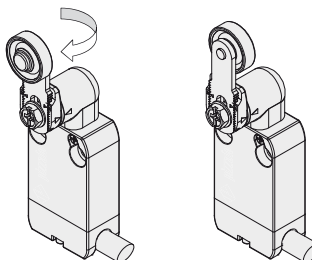

For switches with swivelling lever, the lever can be fastened on straight or reverse side maintaining the positive coupling.

In this way two different working planes of the lever are possible.

Adjustable levers

For switches with swivelling lever, the lever can be adjusted in 10° steps over the entire 360° range.

The positive movement transmission is always guaranteed thanks to the particular geometrical coupling between the lever and the revolving shaft as prescribed for safety applications by the German standard BG-GS-ET-15.

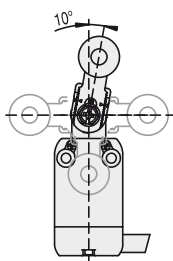

Orientable cable outputs

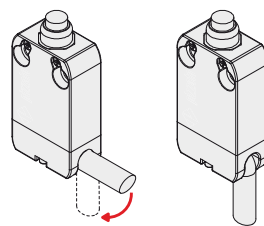

The connector with cable is provided with a cavity to allow cable bending up to 90°.

In this way a flush wall mounting is also possible as well as an easier adjustment of the cable to the supporting flange.

Unidirectional heads

All switches with swivelling lever are supplied with a selector for choosing the lever operating direction.

The following operations are possible: right/left (standard factory setting), only from the right or only from the left. The operating direction can be selected by rotating the dedicated ring mounted on all heads of this kind.

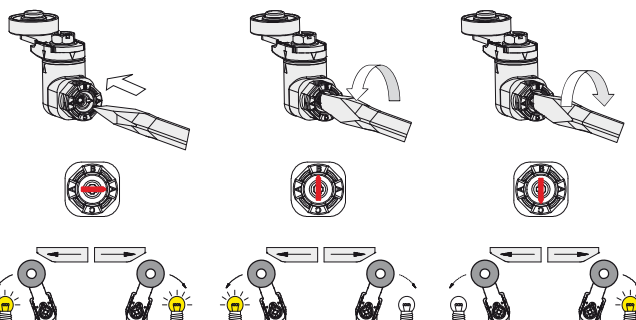

Positive opening contact blocks with 1, 2, 3 or 4 poles

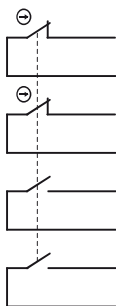

These series of contact blocks are versatile and compact. They have the same dimensions of the previous versions, but now it is possible to have up to 4 different contacts which are galvanically separated and provided with positive opening (NC contacts).

The allowed standard combinations are: 1NO+1NC, 2NC, 1NO+2NC, 2NO+2NC. Other combinations available on request.

The contact blocks have been designed so that they keep the same pin assignment on the connector independently of the action type (slow or snap action) and the number of contacts. In this way, the same cables with connector can be used for units with slow action and snap action as well.

Increased or reduced actuating force

For actuators with swivelling lever, versions with increased or reduced actuating force are available upon request, in order to have a switch perfectly tailored for the application. For further information contact our technical department.

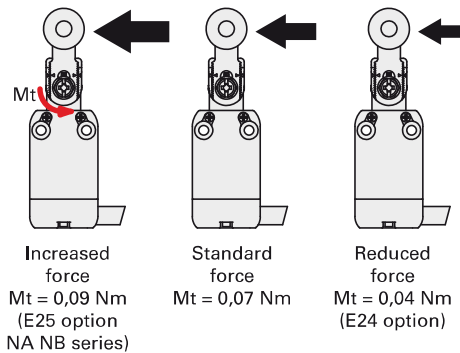

Adjustable levers with anti-unscrewing washer

In some applications during the installation of the switches problems are encountered due to the variability of the fastenings and the folds of the structural work.

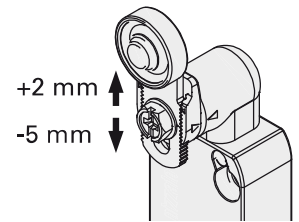

In other cases, small finishing adjustments are required due to the application. Nearly all swivelling levers for switches of the NA, NB and NF series can be adjusted in 1 mm steps along the switch length.

This feature, combined with the additional possibility of the radial adjustment of the actuator, provides the installer with a never before achieved flexibility in the final adjustment of the product.

All this while maintaining the positive geometric locking between lever and swivel shaft as prescribed for safety applications.

90° redirection for actuators

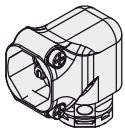

This component highly extends the application possibilities of this product range.

All the actuators that can be attached directly to the body of the switch can also be fastened on this transmission, thus making feasible applications and positioning of the switch that were previously impos-

sible. The redirection piece can also be used in case of heads for swivelling levers. Although possible, the use of multiple transmissions in series is not recommended.

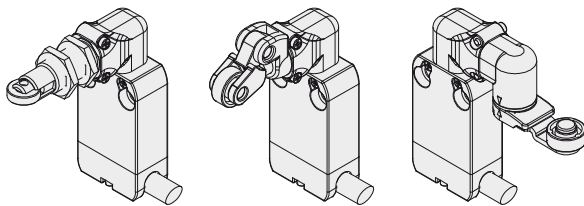

Switch components available separately

This product series has been provided with a modular design so that single parts can also be ordered separately. This is an asset both for distributors and for final customers of electrical material in the procurement of spare parts as well as for custom combinations.

NA B110BB-DN2 **NA B11000** **VN AA0BB** **VN CM11DN2**

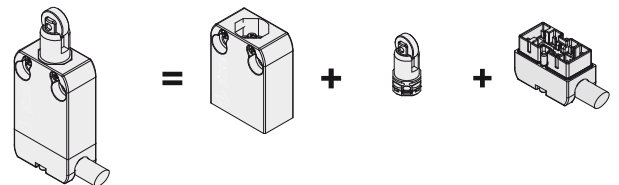

Reversible housing

Thanks to the shape of the fixing holes and of the switch body, as well as the possibility of rotating the head, make this switch perfectly symmetrical.

If a switch with cable output on the left (since the connector cannot be rotated) is required, it is possible to rotate the complete device by maintaining the final position of the actuator unchanged.

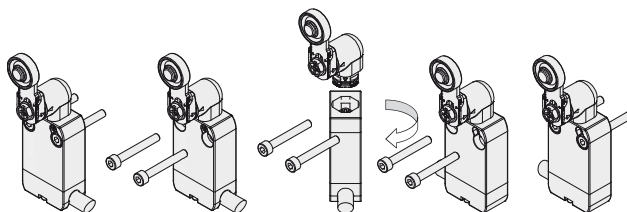

M12 connectors

All contact configurations are available with M12 connector both with two contacts (with 5-pin M12 connector) as well as 3 or 4 contacts (with 8-pin M12 connector). With exit direction below or to the right, these make application in narrow spaces possible, as, with the simple rotation of the switch, the reversible housing also easily allows the exit direction to the left. The M12 connector is also available at the end of the cable, whose length can be tailored to the customer, and the cable can be bent at 90°, allowing installation on walls.

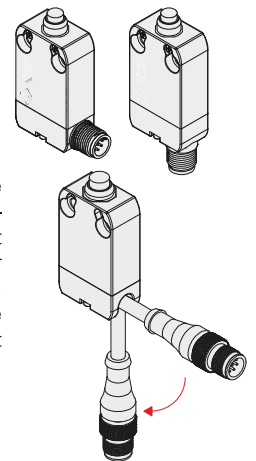

Extended temperature range

-40°C

These devices are also available in a special version suitable for an ambient operating temperature range from -40°C up to +80°C.

They can therefore be used for applications in cold stores, sterilisers and other equipment with low temperature environments. The special materials used to produce these versions retain their characteristics even under these conditions, thereby expanding the installation possibilities.

AMP connectors

Furthermore, AMP connectors for 2-contact versions are available too. These connectors, specially developed for the automotive industry, are immune to vibration due to the quick coupling.

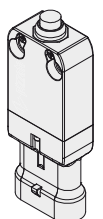

Selection diagram for item combinations of the NA-NB series

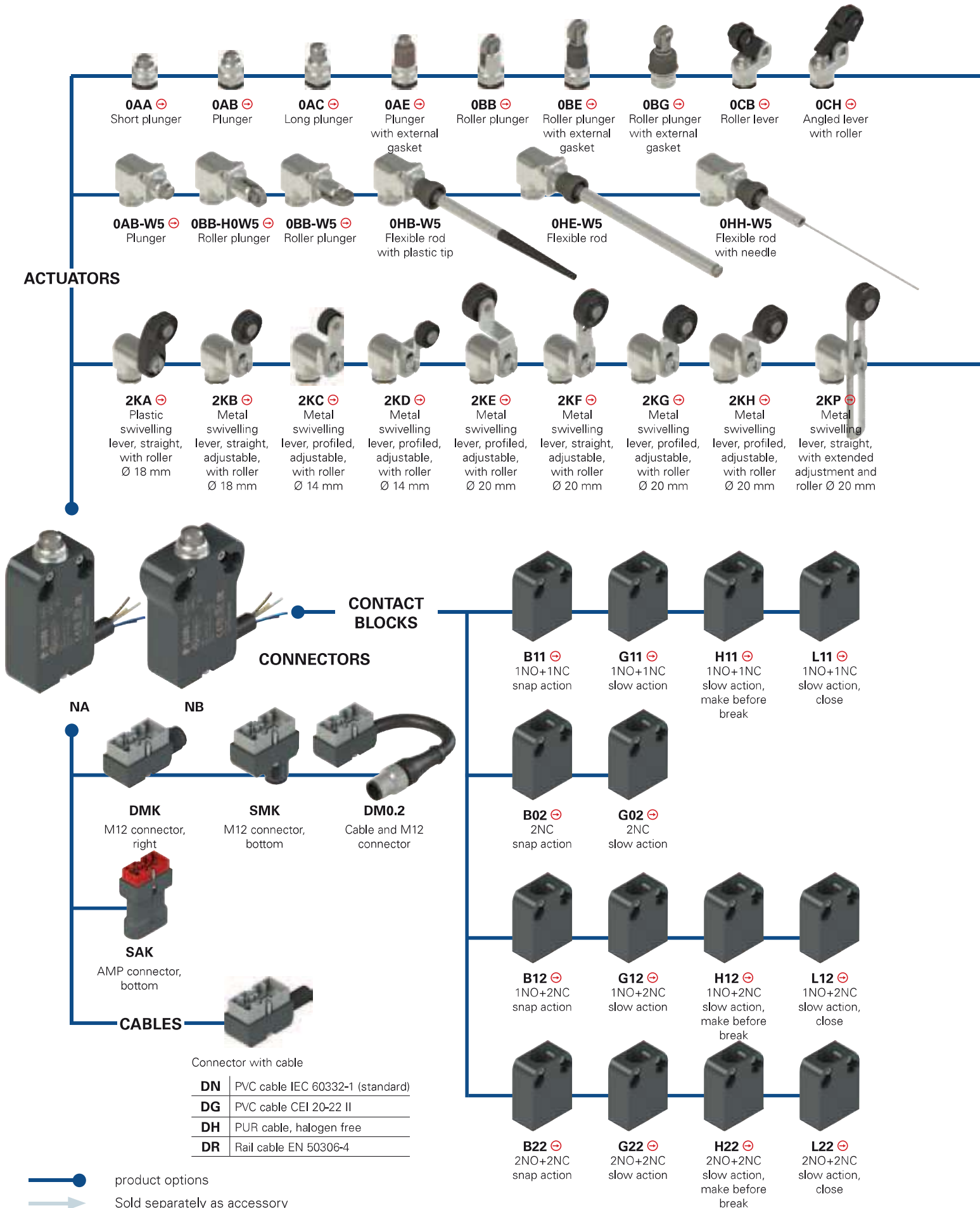

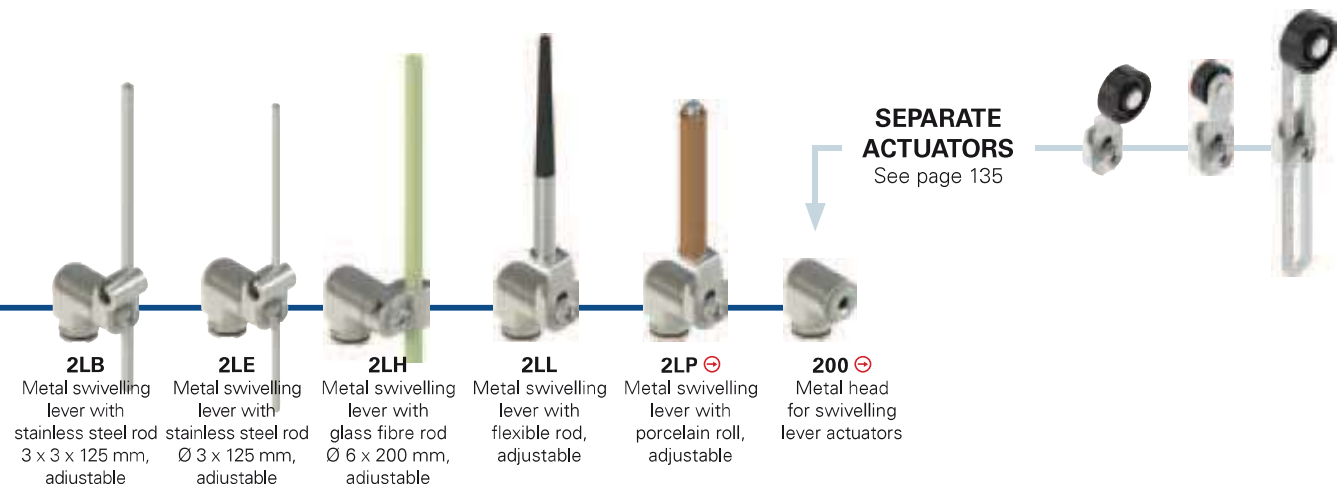
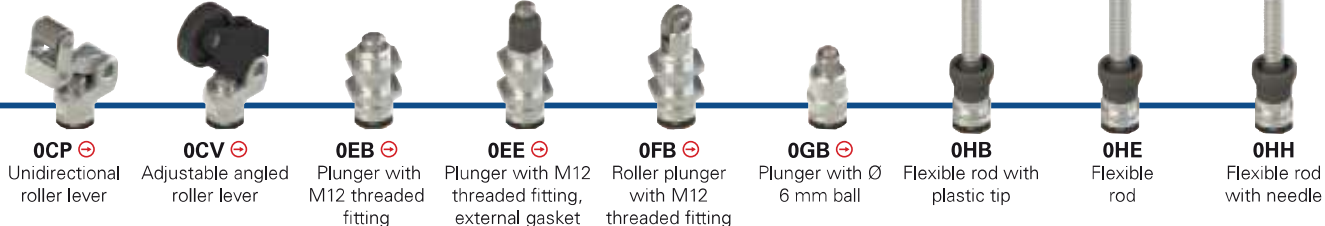

SEPARATE ACTUATORS
See page 135

Code structure

Attention! The feasibility of a code number does not mean the effective availability of a product. Please contact our sales office.

article options
NA B110AB-DN2 GR7T6W5

Housing	
NA	metal, hole spacing 20 mm (standard)
NB	metal, hole spacing 25 mm

Contact block	
B11	1NO+1NC, snap action (standard)
B02	2NC, snap action (standard)
B12	1NO+2NC, snap action (standard)
B22	2NO+2NC, snap action (standard)
BA1	1NO+1NC, snap action, change-over (available with M connector only)
G11	1NO+1NC, slow action (standard)
G02	2NC, slow action (standard)
G12	1NO+2NC, slow action (standard)
G22	2NO+2NC, slow action
H11	1NO+1NC, slow action, make before break
H12	1NO+2NC, slow action, make before break
H22	2NO+2NC, slow action, make before break
L11	1NO+1NC, slow action, close
L12	1NO+2NC, slow action, close
L22	2NO+2NC, slow action, close

Other contact blocks on request.

Actuator heads	
0	without head
2	head for swivelling lever actuators

Actuators	
00	without actuator
AA	short plunger
AB	plunger
...

Output direction	
D	cable or connector, right
S	connector, bottom

Redirection	
	without redirection
W5	90° redirection

Ambient temperature	
	-25 °C ... +80 °C
T6	-40 °C ... +80 °C

Rollers	
	standard roller
R30	stainless steel Ø 10.6 mm
R29	stainless steel Ø 13 mm
R18	technopolymer, Ø 14 mm
R23	stainless steel Ø 14 mm
R7	technopolymer, Ø 18 mm
R22	technopolymer, Ø 20 mm
R24	stainless steel Ø 20 mm
R19	technopolymer, Ø 22 mm
R25	technopolymer, Ø 35 mm

Contact type	
	silver contacts (standard)
G	silver contacts, 1 µm gold coating

Connection type	
0.2	cable, length: 0.2 m with M12 connector (available for DM0.2 versions only)
2	cable, length: 2 m (standard)
5	cable, length 5 m (other cable lengths available on request)
K	integrated connector

Cable or connector type	
N	PVC cable IEC 60332-1 (standard)
G	PVC cable CEI 20-22 II
H	PUR cable, halogen free
R	Rail cable EN 50306-4
M	M12 connector
A	AMP Superseal 1.5 connector



Main features

- Metal housing, right or bottom cable output
- Protection degrees IP67 and IP69K
- 4 types of integrated cable available
- Versions with M12 connector suitable for safety applications ⊕
- Versions with AMP connector
- 14 contact blocks available
- 36 actuators available

Quality marks:



IMQ approval:	CA02.04562
UL approval:	E131787
CCC approval:	2013010305653520
EAC approval:	RU C-IT.A.135.B.00454

⚠ Installation for safety applications:

Use only switches marked with the symbol ⊕ next to the product code. Always connect the safety circuit to the **NC contacts** (normally closed contacts: see "Internal cable wiring" on page 118) as required by **EN ISO 14119, paragraph 5.4** for specific interlock applications and **EN ISO 13849-2 tables D3 (well-tries components) and D.8 (failure exclusions)** for safety applications in general. Actuate the switch **at least up to the positive opening travel** shown in the travel diagrams on page 220. Actuate the switch **at least with the positive opening force**, reported in brackets below each article, next to the actuating force value.

⚠ **If not expressly indicated in this chapter, for correct installation and utilization of all articles see the instructions given on pages 211 to 222.**

⚠ **Important: Switch off the circuit voltage before disconnecting the connector from the switch. The connector is not suitable for separation of electrical loads. According to EN 60204-1, versions with 8-pole M12 (2NO+2NC) and AMP connector can be used only in PELV circuits.**

Features approved by IMQ

Rated insulation voltage (U):	250 Vac
Conventional free air thermal current (I _{th}):	10 A (1-2 contacts) / 6 A (2-3 contacts) / 4 A (4 contacts or 5-pole M12 connector)
Protection against short circuits (fuse):	10 A (1-2 contacts) / 6 A (2-3 contacts) / 4 A (4 contacts or 5-pole M12 connector) type gG
Rated impulse withstand voltage (U _{imp}):	4 kV
Protection degree of the housing:	IP67
MA terminals (crimped terminals)	3
Pollution degree:	3
Utilization category:	AC15 / DC13 (with connector)
Operating voltage (U _e):	250 Vac (50 Hz) / 24 Vdc (with connector)
Operating current (I _e):	3 A / 2 A (with connector)

Forms of the contact element: X, Y, X+Y, X+X, Y+Y, Y+Y+X, X+X+Y, X+X+Y+Y, Zb
 Positive opening of contacts on contact blocks B01, B11, B02, B12, B21, B22, G01, G11, G02, G12, G21, G22, L01, L11, L02, L12, L21, L22, H01, H11, H02, H12, H21, H22

In compliance with standards: EN 60947-1, EN 60947-5-1 + A1:2009, fundamental requirements of the Low Voltage Directive 2014/35/EU.

Please contact our technical department for the list of approved products.

Technical data

Housing

Metal housing, baked with UV resistant powder coating.

Versions with integrated cable, standard length 2 m, other lengths 0.5 ... 10 m on request.

Versions with integrated M12 connector.

Versions with 0.2 m cable length and M12 connector, other lengths 0.1 ... 3 m available on request.

Protection degree:

IP67 acc. to EN 60529

IP69K acc. to ISO 20653

(Protect the cables from direct high-pressure and high-temperature jets)

Corrosion resistance in saline mist:

≥ 300 hours in NSS acc. to ISO 9227

General data

Ambient temperature for switches without cable: -25°C ... + 80°C (standard)

-40°C ... + 80°C (extended T6)

Ambient temperature for switches with cable:

See table on page 118

Max. actuation frequency:

3600 operating cycles/hour

Mechanical endurance:

20 million operating cycles

Mounting position:

any

Safety parameter B_{10D}:

40,000,000 for NC contacts

Mechanical interlock, not coded:

type 1 acc. to EN ISO 14119

Vibration resistance

5 ... 150 Hz (7.9 m/s²)

(0BB, 2KB, 2KC, 2KD actuators):

acc. to EN 61373 cl. 9

Tightening torques for installation:

see page 211-222

Electrical data

Rated impulse withstand voltage (U_{imp}):

4 kV

Conditional short circuit current:

1000 A acc. to EN 60947-5-1

Pollution degree:

3

In compliance with standards:

IEC 60947-5-1, EN 60947-5-1, IEC 60204-1, EN 60204-1, EN ISO 14119, EN ISO 12100, IEC 60529, EN 60529, ISO 20653, UL 508, CSA 22.2 No.14.

Compliance with the requirements of:

Low Voltage Directive 2014/35/EU, EMC Directive 2014/30/EU.

Positive contact opening in conformity with standards:

IEC 60947-5-1, EN 60947-5-1.

Features approved by UL

Utilization categories	R300 pilot duty (28 VA, 125-250 Vdc) B300 pilot duty (360 VA, 120-240 Vac) (1-2-3 cont.) C300 pilot duty (180 VA, 120-240 Vac) (4 cont.)
Housing features type 1, 4X "indoor use only"; 12.	
Housing features for the version with 1-2 contacts and type N cable	Type 1, 4X "indoor use only"
In compliance with standard:	UL 508, CSA 22.2 No.14

Please contact our technical department for the list of approved products.



Ambient temperatures for switches with cable and electrical data

Connection type	Output with cable								Output with M12 connector		Output with AMP connector
	2 contacts				3 contacts		4 contacts		2 contacts	3 or 4 contacts	2 contacts
	N	G	H	R	N	H	N	R	M12 connector, 5-pole	M12 connector, 8-pole	AMP Super-seal 1.5 connector
Cable or connector type	N	G	H	R	N	H	N	R	M12 connector, 5-pole	M12 connector, 8-pole	AMP Super-seal 1.5 connector
Conductors	5x0.75 mm ²	5x0.75 mm ²	5x0.75 mm ²	5x0.5 mm ²	7x0.5 mm ²	7x0.5 mm ²	9x0.34 mm ²	9x0.5 mm ²	5x0.25 mm ²	8x0.25 mm ²	
Application field	General	General	General, mobile installation	Rail	General	General, mobile installation	General	Rail	General	General	General
In compliance with standards	05VV-F	05VV-F	05EQ-H	EN50306-4 IE-300V 5G0.5 mm ² MM-30 EN 50306-4 EN 45545	03VV-F	03E7Q-H	03VV-F	EN50306-4 1P-300V 9G0.5 mm ² MM-30 EN 50306-4 EN 45545	03VV-H	03VV-H	/
Sheath	PVC	PVC	PUR HALOGEN FREE	/	PVC	PUR HALOGEN FREE	PVC	/	PVC	PVC	/
Self-extinguishing	IEC 60332-1-2 IEC 60332-1-3	IEC 60332-1-2 IEC 60332-1-3 IEC 60332-3 CEI 20-22 II	IEC 60332-1-2 IEC 60332-1-3	IEC 60332-1 EN 50305 EN 50306-1	IEC 60332-1-2 IEC 60332-1-3	IEC 60332-1-2 IEC 60332-1-3	IEC 60332-1-2 IEC 60332-1-3	IEC 60332-1 EN 50305 EN 50306-1	IEC 60332-3 CEI 20-22 II	IEC 60332-3 CEI 20-22 II	/
Oil resistant	/	/	UL 758	/	/	UL 758	/	/	ISO 6722-1	ISO 6722-1	/
Max. speed	/	/	100 m/min	/	/	300 m/min	/	/	50m/min	50m/min	/
Max. acceleration	/	/	2 m/s ²	/	/	25 m/s ²	/	/	5m/s ²	5m/s ²	/
Minimum bending radius	80 mm	80 mm	80 mm	60 mm	108 mm	108 mm	94 mm	65 mm	75 mm	90 mm	/
Outer diameter	8 mm	8 mm	8 mm	6 mm	7 mm	7 mm	7 mm	6.5 mm	5 mm	6 mm	/
End stripped	80 mm	80 mm	80 mm	80 mm	80 mm	80 mm	80 mm	80 mm	/	/	/
Copper conductors IEC 60228	Class 5	Class 5	Class 6	Class 5	Class 5	Class 6	Class 5	Class 5	Class 6	Class 6	/

Ambient temperature with cable extended (T ₀) standard	Cable, fixed installation	-25°C +70°C	-25°C +70°C	-25°C +80°C	-25°C +80°C	-25°C +80°C	-25°C +80°C	-25°C +80°C	-25°C +80°C	-25°C +80°C	-25°C +80°C	/	
	Cable, flexible installation	+5°C +70°C	-25°C +70°C	-25°C +80°C	-25°C +80°C	-5°C +80°C	-25°C +80°C	-5°C +80°C	-25°C +80°C	-25°C +80°C	-25°C +80°C	/	
	Cable, mobile installation	/	/	-25°C +80°C	/	/	-25°C +80°C	/	/	-15°C +80°C	-15°C +80°C	/	
	Cable, fixed installation	/	/	-40°C +80°C	-40°C ... +80°C	/	-40°C +80°C	/	-40°C +80°C	/	/	/	
	Cable, flexible installation	/	/	-40°C +80°C	-40°C +80°C	/	-30°C +80°C	/	-40°C +80°C	/	/	/	
	Cable, mobile installation	/	/	-40°C +80°C	/	/	-30°C +80°C	/	/	/	/	/	
	Electrical data	Thermal current I _{th}	10 A	10 A	10 A	6 A	6 A	6 A	3 A	4 A	4 A	2 A	10 A
Rated insulation voltage U _i		250 Vac	250 Vac	250 Vac	250 Vac	250 Vac	250 Vac	250 Vac	250 Vac	250 Vac	300 Vdc 36 Vdc	250 Vac 300 Vdc	
Protection against short circuits (fuse)		10 A 500 V type gG	10 A 500 V type gG	10 A 500 V type gG	6 A 500 V type gG	6 A 500 V type gG	6 A 500 V type gG	3 A 500 V type gG	4 A 500 V type gG	4 A 500 V type gG	2 A 500V type gG	10 A 500 V type gG	
Utilization category DC13		24 V	2 A	2 A	2 A	2 A	2 A	2 A	2 A	2 A	2 A	2 A	2 A
		125 V	0.4 A	0.4 A	0.4 A	0.4 A	0.4 A	0.4 A	0.4 A	0.4 A	0.4 A	/	0.4 A
		250 V	0.3 A	0.3 A	0.3 A	0.3 A	0.3 A	0.3 A	0.3 A	0.3 A	0.3 A	/	0.3 A
Utilization category AC15		24 V	4 A	4 A	4 A	4 A	4 A	4 A	3 A	4 A	4 A	2 A	4 A
	120 V	4 A	4 A	4 A	4 A	4 A	4 A	3 A	4 A	4 A	/	4 A	
	250 V	4 A	4 A	4 A	4 A	4 A	4 A	3 A	4 A	4 A	/	4 A	
Approvals	CE cULus IMQ EAC CCC	CE EAC CCC	CE cULus IMQ EAC CCC	CE IMQ EAC CCC	CE cULus IMQ EAC CCC	CE cULus IMQ EAC CCC	CE cULus IMQ EAC CCC	CE cULus IMQ EAC CCC	CE IMQ EAC CCC	CE cULus IMQ EAC CCC	CE cULus EAC CCC	CE cULus EAC CCC	

Internal cable wiring

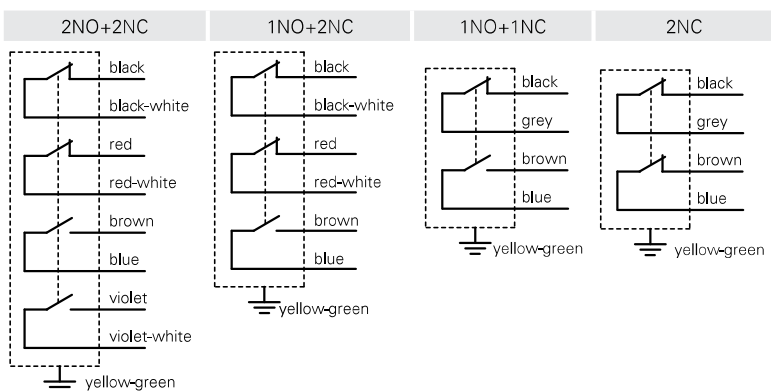

Connector pin assignment

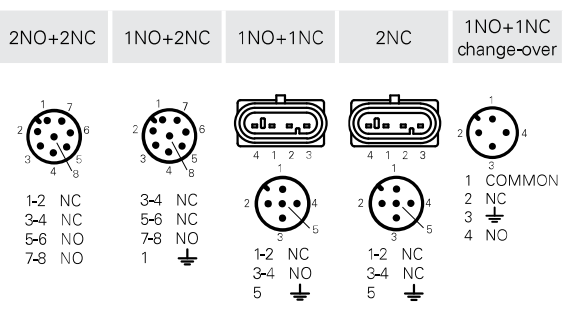

Female connectors see page 198

Contact type:

R = snap action
L = slow action

Contact block

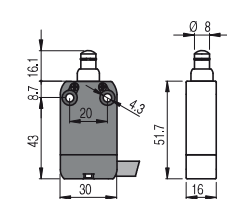
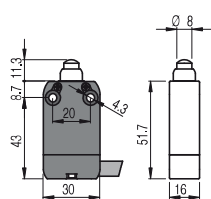
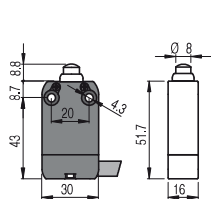

With external rubber gasket

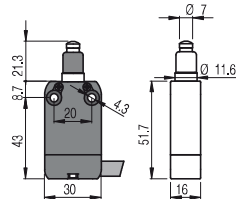

B11	R	NA B110AA-DN2	➔ 1NO+1NC	NA B110AB-DN2	➔ 1NO+1NC	NA B110AC-DN2	➔ 1NO+1NC	NA B110AE-DN2	➔ 1NO+1NC
B02	R	NA B020AA-DN2	➔ 2NC	NA B020AB-DN2	➔ 2NC	NA B020AC-DN2	➔ 2NC	NA B020AE-DN2	➔ 2NC
B12	R	NA B120AA-DN2	➔ 1NO+2NC	NA B120AB-DN2	➔ 1NO+2NC	NA B120AC-DN2	➔ 1NO+2NC	NA B120AE-DN2	➔ 1NO+2NC
B22	R	NA B220AA-DN2	➔ 2NO+2NC	NA B220AB-DN2	➔ 2NO+2NC	NA B220AC-DN2	➔ 2NO+2NC	NA B220AE-DN2	➔ 2NO+2NC
G11	L	NA G110AA-DN2	➔ 1NO+1NC	NA G110AB-DN2	➔ 1NO+1NC	NA G110AC-DN2	➔ 1NO+1NC	NA G110AE-DN2	➔ 1NO+1NC
G02	L	NA G020AA-DN2	➔ 2NC	NA G020AB-DN2	➔ 2NC	NA G020AC-DN2	➔ 2NC	NA G020AE-DN2	➔ 2NC
G12	L	NA G120AA-DN2	➔ 1NO+2NC	NA G120AB-DN2	➔ 1NO+2NC	NA G120AC-DN2	➔ 1NO+2NC	NA G120AE-DN2	➔ 1NO+2NC
G22	L	NA G220AA-DN2	➔ 2NO+2NC	NA G220AB-DN2	➔ 2NO+2NC	NA G220AC-DN2	➔ 2NO+2NC	NA G220AE-DN2	➔ 2NO+2NC
Max. speed		page 219 - type 4		page 219 - type 4		page 219 - type 4		page 219 - type 4	
Actuating force		7 N (25 N ➔)		7 N (25 N ➔)		7 N (25 N ➔)		7 N (25 N ➔)	
Travel diagrams		page 220 - group 1		page 220 - group 1		page 220 - group 1		page 220 - group 1	

Contact block

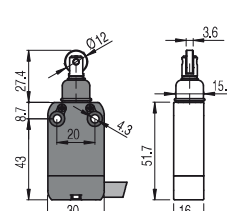
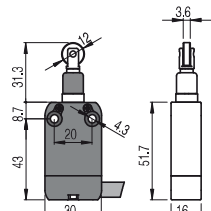
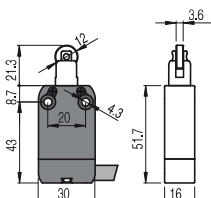

With stainless steel roller on request

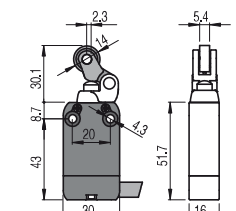

B11	R	NA B110BB-DN2	➔ 1NO+1NC	NA B110BE-DN2	➔ 1NO+1NC	NA B110BG-DN2	➔ 1NO+1NC	NA B110CB-DN2	➔ 1NO+1NC
B02	R	NA B020BB-DN2	➔ 2NC	NA B020BE-DN2	➔ 2NC	NA B020BG-DN2	➔ 2NC	NA B020CB-DN2	➔ 2NC
B12	R	NA B120BB-DN2	➔ 1NO+2NC	NA B120BE-DN2	➔ 1NO+2NC	NA B120BG-DN2	➔ 1NO+2NC	NA B120CB-DN2	➔ 1NO+2NC
B22	R	NA B220BB-DN2	➔ 2NO+2NC	NA B220BE-DN2	➔ 2NO+2NC	NA B220BG-DN2	➔ 2NO+2NC	NA B220CB-DN2	➔ 2NO+2NC
G11	L	NA G110BB-DN2	➔ 1NO+1NC	NA G110BE-DN2	➔ 1NO+1NC	NA G110BG-DN2	➔ 1NO+1NC	NA G110CB-DN2	➔ 1NO+1NC
G02	L	NA G020BB-DN2	➔ 2NC	NA G020BE-DN2	➔ 2NC	NA G020BG-DN2	➔ 2NC	NA G020CB-DN2	➔ 2NC
G12	L	NA G120BB-DN2	➔ 1NO+2NC	NA G120BE-DN2	➔ 1NO+2NC	NA G120BG-DN2	➔ 1NO+2NC	NA G120CB-DN2	➔ 1NO+2NC
G22	L	NA G220BB-DN2	➔ 2NO+2NC	NA G220BE-DN2	➔ 2NO+2NC	NA G220BG-DN2	➔ 2NO+2NC	NA G220CB-DN2	➔ 2NO+2NC
Max. speed		page 219 - type 2		page 219 - type 5		page 219 - type 5		page 219 - type 3	
Actuating force		7 N (25 N ➔)		7 N (25 N ➔)		7 N (25 N ➔)		5 N (25 N ➔)	
Travel diagrams		page 220 - group 1		page 220 - group 1		page 220 - group 1		page 220 - group 2	

NB series housing

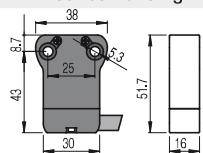

M12 connector, right

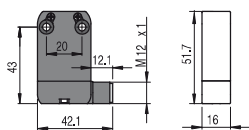

M12 connector, bottom

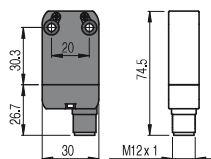

AMP Superseal 1.5 connector

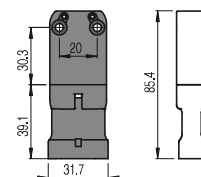

To order a product of the NB series, replace NA with NB in the codes shown above. Example:
NA B110AA-DN2 → NB B110AA-DN2

To order a product with M12 right connector, replace DN2 with DMK in the codes shown above. Example:
NA B110AA-DN2 → NA B110AA-DMK

To order a product with M12 bottom connector, replace DN2 with SMK in the codes shown above. Example:
NA B110AA-DN2 → NA B110AA-SMK

To order a product with AMP connector, replace DN2 with SAK in the codes shown above. Example:
NA B110AA-DN2 → NA B110AA-SAK

All values in the drawings are in mm

Items with code on green background are stock items

Accessories See page 197

→ The 2D and 3D files are available at www.pizzato.com



Contact type: R = snap action L = slow action	With stainless steel roller on request	Unidirectional operation		Secured only by means of threaded head
Contact block				
B11 R	NA B110CH-DN2 (1NO+1NC)	NA B110CP-DN2 (1NO+1NC)	NA B110CV-DN2 (1NO+1NC)	NA B110EB-DN2 (1NO+1NC)
B02 R	NA B020CH-DN2 (2NC)	NA B020CP-DN2 (2NC)	NA B020CV-DN2 (2NC)	NA B020EB-DN2 (2NC)
B12 R	NA B120CH-DN2 (1NO+2NC)	NA B120CP-DN2 (1NO+2NC)	NA B120CV-DN2 (1NO+2NC)	NA B120EB-DN2 (1NO+2NC)
B22 R	NA B220CH-DN2 (2NO+2NC)	NA B220CP-DN2 (2NO+2NC)	NA B220CV-DN2 (2NO+2NC)	NA B220EB-DN2 (2NO+2NC)
G11 L	NA G110CH-DN2 (1NO+1NC)	NA G110CP-DN2 (1NO+1NC)	NA G110CV-DN2 (1NO+1NC)	NA G110EB-DN2 (1NO+1NC)
G02 L	NA G020CH-DN2 (2NC)	NA G020CP-DN2 (2NC)	NA G020CV-DN2 (2NC)	NA G020EB-DN2 (2NC)
G12 L	NA G120CH-DN2 (1NO+2NC)	NA G120CP-DN2 (1NO+2NC)	NA G120CV-DN2 (1NO+2NC)	NA G120EB-DN2 (1NO+2NC)
G22 L	NA G220CH-DN2 (2NO+2NC)	NA G220CP-DN2 (2NO+2NC)	NA G220CV-DN2 (2NO+2NC)	NA G220EB-DN2 (2NO+2NC)
Max. speed	page 219 - type 3	page 219 - type 3	page 219 - type 3	page 219 - type 4
Actuating force	5 N (25 N →)	3 N (25 N →)	3 N (25 N →)	7 N (25 N →)
Travel diagrams	page 220 - group 2	page 220 - group 6	page 220 - group 3	page 220 - group 1

Contact block	Secured only by means of threaded head With external rubber gasket	Secured only by means of threaded head	Plunger with Ø 6 mm ball	With external rubber gasket
B11 R	NA B110EE-DN2 (1NO+1NC)	NA B110FB-DN2 (1NO+1NC)	NA B110GB-DN2 (1NO+1NC)	NA B110HB-DN2 (1NO+1NC)
B02 R	NA B020EE-DN2 (2NC)	NA B020FB-DN2 (2NC)	NA B020GB-DN2 (2NC)	NA B020HB-DN2 (2NC)
B12 R	NA B120EE-DN2 (1NO+2NC)	NA B120FB-DN2 (1NO+2NC)	NA B120GB-DN2 (1NO+2NC)	NA B120HB-DN2 (1NO+2NC)
B22 R	NA B220EE-DN2 (2NO+2NC)	NA B220FB-DN2 (2NO+2NC)	NA B220GB-DN2 (2NO+2NC)	NA B220HB-DN2 (2NO+2NC)
G11 L	NA G110EE-DN2 (1NO+1NC)	NA G110FB-DN2 (1NO+1NC)	NA G110GB-DN2 (1NO+1NC)	
G02 L	NA G020EE-DN2 (2NC)	NA G020FB-DN2 (2NC)	NA G020GB-DN2 (2NC)	NA G020HB-DN2 (2NC)
G12 L	NA G120EE-DN2 (1NO+2NC)	NA G120FB-DN2 (1NO+2NC)	NA G120GB-DN2 (1NO+2NC)	
G22 L	NA G220EE-DN2 (2NO+2NC)	NA G220FB-DN2 (2NO+2NC)	NA G220GB-DN2 (2NO+2NC)	
Max. speed	page 219 - type 4	page 219 - type 2	page 219 - type 2	1 m/s
Actuating force	7 N (25 N →)	7 N (25 N →)	7 N (25 N →)	0.03 Nm
Travel diagrams	page 220 - group 1	page 220 - group 1	page 220 - group 1	page 220 - group 4

Cable and M12 connector

All values in the drawings are in mm

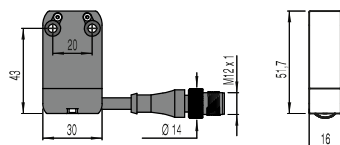

To order a product with cable and M12 connector:
replace DN2 with DM0.2 in the codes shown above. Example:
NA B110AA-DN2 → NA B110AA-DM0.2

Contact type:

R = snap action
L = slow action

	With external rubber gasket		With external rubber gasket		With stainless steel roller on request		With stainless steel roller on request	
Contact block								
B11	R	NA B110HE-DN2 1NO+1NC	NA B110HH-DN2 1NO+1NC	NA B112KA-DN2 \rightarrow 1NO+1NC	NA B112KB-DN2 \rightarrow 1NO+1NC			
B02	R	NA B020HE-DN2 2NC	NA B020HH-DN2 2NC	NA B022KA-DN2 \rightarrow 2NC	NA B022KB-DN2 \rightarrow 2NC			
B12	R	NA B120HE-DN2 1NO+2NC	NA B120HH-DN2 1NO+2NC	NA B122KA-DN2 \rightarrow 1NO+2NC	NA B122KB-DN2 \rightarrow 1NO+2NC			
B22	R	NA B220HE-DN2 2NO+2NC	NA B220HH-DN2 2NO+2NC	NA B222KA-DN2 \rightarrow 2NO+2NC	NA B222KB-DN2 \rightarrow 2NO+2NC			
G11	L			NA G112KA-DN2 \rightarrow 1NO+1NC	NA G112KB-DN2 \rightarrow 1NO+1NC			
G02	L	NA G020HE-DN2 2NC	NA G020HH-DN2 2NC	NA G022KA-DN2 \rightarrow 2NC	NA G022KB-DN2 \rightarrow 2NC			
G12	L			NA G122KA-DN2 \rightarrow 1NO+2NC	NA G122KB-DN2 \rightarrow 1NO+2NC			
G22	L			NA G222KA-DN2 \rightarrow 2NO+2NC	NA G222KB-DN2 \rightarrow 2NO+2NC			
Max. speed	1 m/s		1 m/s		page 219 - type 1		page 219 - type 1	
Actuating force	0,07 Nm		0,03 Nm		0,07 Nm (0,25 Nm \rightarrow)		0,07 Nm (0,25 Nm \rightarrow)	
Travel diagrams	page 220 - group 4		page 220 - group 4		page 220 - group 5		page 220 - group 5	

	With stainless steel roller on request		With stainless steel roller on request		With stainless steel roller on request		With stainless steel roller on request	
Contact block								
B11	R	NA B112KC-DN2 \rightarrow 1NO+1NC	NA B112KD-DN2 \rightarrow 1NO+1NC	NA B112KE-DN2 \rightarrow 1NO+1NC	NA B112KF-DN2 \rightarrow 1NO+1NC			
B02	R	NA B022KC-DN2 \rightarrow 2NC	NA B022KD-DN2 \rightarrow 2NC	NA B022KE-DN2 \rightarrow 2NC	NA B022KF-DN2 \rightarrow 2NC			
B12	R	NA B122KC-DN2 \rightarrow 1NO+2NC	NA B122KD-DN2 \rightarrow 1NO+2NC	NA B122KE-DN2 \rightarrow 1NO+2NC	NA B122KF-DN2 \rightarrow 1NO+2NC			
B22	R	NA B222KC-DN2 \rightarrow 2NO+2NC	NA B222KD-DN2 \rightarrow 2NO+2NC	NA B222KE-DN2 \rightarrow 2NO+2NC	NA B222KF-DN2 \rightarrow 2NO+2NC			
G11	L	NA G112KC-DN2 \rightarrow 1NO+1NC	NA G112KD-DN2 \rightarrow 1NO+1NC	NA G112KE-DN2 \rightarrow 1NO+1NC	NA G112KF-DN2 \rightarrow 1NO+1NC			
G02	L	NA G022KC-DN2 \rightarrow 2NC	NA G022KD-DN2 \rightarrow 2NC	NA G022KE-DN2 \rightarrow 2NC	NA G022KF-DN2 \rightarrow 2NC			
G12	L	NA G122KC-DN2 \rightarrow 1NO+2NC	NA G122KD-DN2 \rightarrow 1NO+2NC	NA G122KE-DN2 \rightarrow 1NO+2NC	NA G122KF-DN2 \rightarrow 1NO+2NC			
G22	L	NA G222KC-DN2 \rightarrow 2NO+2NC	NA G222KD-DN2 \rightarrow 2NO+2NC	NA G222KE-DN2 \rightarrow 2NO+2NC	NA G222KF-DN2 \rightarrow 2NO+2NC			
Max. speed	page 219 - type 1		page 219 - type 1		page 219 - type 1		page 219 - type 1	
Actuating force	0,07 Nm (0,25 Nm \rightarrow)		0,07 Nm (0,25 Nm \rightarrow)		0,07 Nm (0,25 Nm \rightarrow)		0,07 Nm (0,25 Nm \rightarrow)	
Travel diagrams	page 220 - group 5		page 220 - group 5		page 220 - group 5		page 220 - group 5	

NB series housing	M12 connector, right	M12 connector, bottom	AMP Superseal 1.5 connector
To order a product of the NB series, replace NA with NB in the codes shown above. Example: NA B110AA-DN2 \rightarrow NB B110AA-DN2	To order a product with M12 right connector, replace DN2 with DMK in the codes shown above. Example: NA B110AA-DN2 \rightarrow NA B110AA-DMK	To order a product with M12 bottom connector, replace DN2 with SMK in the codes shown above. Example: NA B110AA-DN2 \rightarrow NA B110AA-SMK	To order a product with AMP connector, replace DN2 with SAK in the codes shown above. Example: NA B110AA-DN2 \rightarrow NA B110AA-SAK

All values in the drawings are in mm

Items with code on green background are stock items

Accessories See page 197

\rightarrow The 2D and 3D files are available at www.pizzato.com



Contact type:	With stainless steel roller on request	With stainless steel roller on request	With stainless steel roller on request	Square rod, 3x3 mm, stainless steel
R = snap action L = slow action				
Contact block				
B11 R	NA B112KG-DN2 \rightarrow 1NO+1NC	NA B112KH-DN2 \rightarrow 1NO+1NC	NA B112KP-DN2 \rightarrow 1NO+1NC	NA B112LB-DN2 1NO+1NC
B02 R	NA B022KG-DN2 \rightarrow 2NC	NA B022KH-DN2 \rightarrow 2NC	NA B022KP-DN2 \rightarrow 2NC	NA B022LB-DN2 2NC
B12 R	NA B122KG-DN2 \rightarrow 1NO+2NC	NA B122KH-DN2 \rightarrow 1NO+2NC	NA B122KP-DN2 \rightarrow 1NO+2NC	NA B122LB-DN2 1NO+2NC
B22 R	NA B222KG-DN2 \rightarrow 2NO+2NC	NA B222KH-DN2 \rightarrow 2NO+2NC	NA B222KP-DN2 \rightarrow 2NO+2NC	NA B222LB-DN2 2NO+2NC
G11 L	NA G112KG-DN2 \rightarrow 1NO+1NC	NA G112KH-DN2 \rightarrow 1NO+1NC	NA G112KP-DN2 \rightarrow 1NO+1NC	NA G112LB-DN2 1NO+1NC
G02 L	NA G022KG-DN2 \rightarrow 2NC	NA G022KH-DN2 \rightarrow 2NC	NA G022KP-DN2 \rightarrow 2NC	NA G022LB-DN2 2NC
G12 L	NA G122KG-DN2 \rightarrow 1NO+2NC	NA G122KH-DN2 \rightarrow 1NO+2NC	NA G122KP-DN2 \rightarrow 1NO+2NC	NA G122LB-DN2 1NO+2NC
G22 L	NA G222KG-DN2 \rightarrow 2NO+2NC	NA G222KH-DN2 \rightarrow 2NO+2NC	NA G222KP-DN2 \rightarrow 2NO+2NC	NA G222LB-DN2 2NO+2NC
Max. speed	page 219 - type 1	page 219 - type 1	page 219 - type 1	1,5 m/s
Actuating force	0,07 Nm (0,25 Nm \rightarrow)	0,07 Nm (0,25 Nm \rightarrow)	0,07 Nm (0,25 Nm \rightarrow)	0,07 Nm
Travel diagrams	page 220 - group 5	page 220 - group 5	page 220 - group 5	page 220 - group 5

Contact block	Round rod, \varnothing 3 mm, stainless steel	Glass fibre rod		Porcelain roller
B11 R	NA B112LE-DN2 1NO+1NC	NA B112LH-DN2 1NO+1NC	NA B112LL-DN2 1NO+1NC	NA B112LP-DN2E24 \rightarrow 1NO+1NC
B02 R	NA B022LE-DN2 2NC	NA B022LH-DN2 2NC	NA B022LL-DN2 2NC	NA B022LP-DN2E24 \rightarrow 2NC
B12 R	NA B122LE-DN2 1NO+2NC	NA B122LH-DN2 1NO+2NC	NA B122LL-DN2 1NO+2NC	NA B122LP-DN2E24 \rightarrow 1NO+2NC
B22 R	NA B222LE-DN2 2NO+2NC	NA B222LH-DN2 2NO+2NC	NA B222LL-DN2 2NO+2NC	NA B222LP-DN2E24 \rightarrow 2NO+2NC
G11 L	NA G112LE-DN2 1NO+1NC	NA G112LH-DN2 1NO+1NC	NA G112LL-DN2 1NO+1NC	NA G112LP-DN2E24 \rightarrow 1NO+1NC
G02 L	NA G022LE-DN2 2NC	NA G022LH-DN2 2NC	NA G022LL-DN2 2NC	NA G022LP-DN2E24 \rightarrow 2NC
G12 L	NA G122LE-DN2 1NO+2NC	NA G122LH-DN2 1NO+2NC	NA G122LL-DN2 1NO+2NC	NA G122LP-DN2E24 \rightarrow 1NO+2NC
G22 L	NA G222LE-DN2 2NO+2NC	NA G222LH-DN2 2NO+2NC	NA G222LL-DN2 2NO+2NC	NA G222LP-DN2E24 \rightarrow 2NO+2NC
Max. speed	1,5 m/s	1,5 m/s	1,5 m/s	0,5 m/s
Actuating force	0,07 Nm	0,07 Nm	0,07 Nm	0,04 Nm
Travel diagrams	page 220 - group 5	page 220 - group 5	page 220 - group 5	page 220 - group 5

Cable and M12 connector

All values in the drawings are in mm

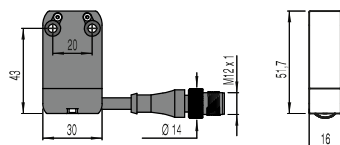

To order a product with cable and M12 connector:
 replace DN2 with DM0.2 in the codes shown above. Example:
 NA B110AA-DN2 \rightarrow NA B110AA-DM0.2

Contact type:

- R = snap action
- L = slow action

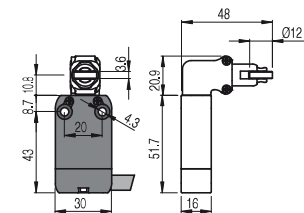
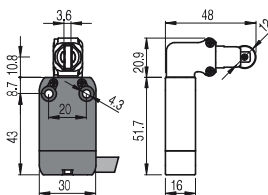
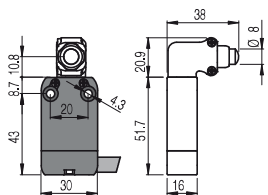

Contact block

B11	R	NA B110AB-DN2W5	↻ 1NO+1NC	NA B110BB-DN2H0W5	↻ 1NO+1NC	NA B110BB-DN2W5	↻ 1NO+1NC
B02	R	NA B020AB-DN2W5	↻ 2NC	NA B020BB-DN2H0W5	↻ 2NC	NA B020BB-DN2W5	↻ 2NC
B12	R	NA B120AB-DN2W5	↻ 1NO+2NC	NA B120BB-DN2H0W5	↻ 1NO+2NC	NA B120BB-DN2W5	↻ 1NO+2NC
B22	R	NA B220AB-DN2W5	↻ 2NO+2NC	NA B220BB-DN2H0W5	↻ 2NO+2NC	NA B220BB-DN2W5	↻ 2NO+2NC
G11	L	NA G110AB-DN2W5	↻ 1NO+1NC	NA G110BB-DN2H0W5	↻ 1NO+1NC	NA G110BB-DN2W5	↻ 1NO+1NC
G02	L	NA G020AB-DN2W5	↻ 2NC	NA G020BB-DN2H0W5	↻ 2NC	NA G020BB-DN2W5	↻ 2NC
G12	L	NA G120AB-DN2W5	↻ 1NO+2NC	NA G120BB-DN2H0W5	↻ 1NO+2NC	NA G120BB-DN2W5	↻ 1NO+2NC
G22	L	NA G220AB-DN2W5	↻ 2NO+2NC	NA G220BB-DN2H0W5	↻ 2NO+2NC	NA G220BB-DN2W5	↻ 2NO+2NC
Max. speed		page 219 - type 4		page 219 - type 2		page 219 - type 2	
Actuating force		9.5 N (25 N ↻)		9.5 N (25 N ↻)		9.5 N (25 N ↻)	
Travel diagrams		page 220 - group 1		page 220 - group 1		page 220 - group 1	

With external gasket

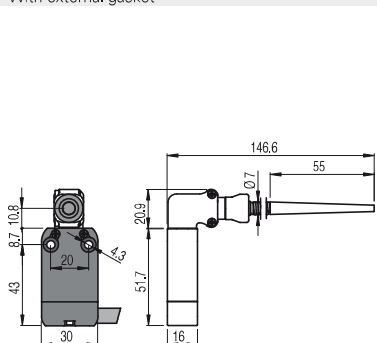

With external gasket

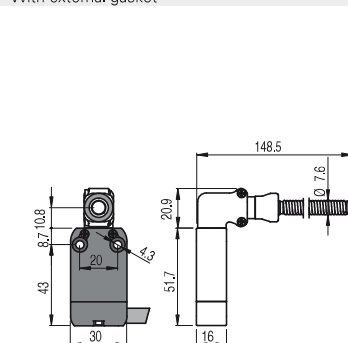

With external gasket

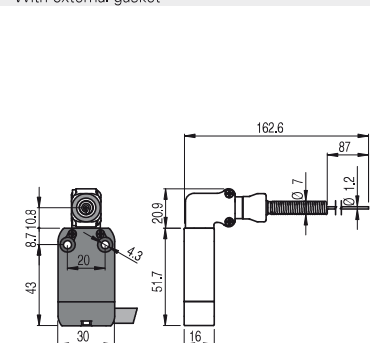

Contact block

B11	R	NA B110HB-DN2W5	1NO+1NC	NA B110HE-DN2W5	1NO+1NC	NA B110HH-DN2W5	1NO+1NC
B02	R	NA B020HB-DN2W5	2NC	NA B020HE-DN2W5	2NC	NA B020HH-DN2W5	2NC
B12	R	NA B120HB-DN2W5	1NO+2NC	NA B120HE-DN2W5	1NO+2NC	NA B120HH-DN2W5	1NO+2NC
B22	R	NA B220HB-DN2W5	2NO+2NC	NA B220HE-DN2W5	2NO+2NC	NA B220HH-DN2W5	2NO+2NC
G11	L						
G02	L	NA G020HB-DN2W5	2NC	NA G020HE-DN2W5	2NC	NA G020HH-DN2W5	2NC
G12	L						
G22	L						
Max. speed		1 m/s		1 m/s		1 m/s	
Actuating force		0.08 Nm		0.12 Nm		0.08 Nm	
Travel diagrams		page 220 - group 4		page 220 - group 4		page 220 - group 4	

NB series housing

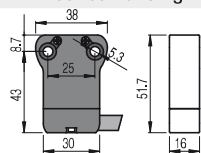

M12 connector, right

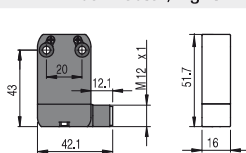

M12 connector, bottom

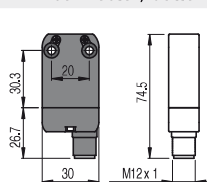

AMP Superseal 1.5 connector

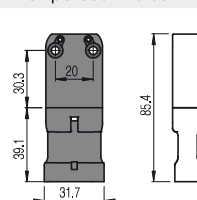

To order a product of the NB series, replace NA with NB in the codes shown above. Example:
NA B110AA-DN2 → NB B110AA-DN2

To order a product with M12 right connector, replace DN2 with DMK in the codes shown above. Example:
NA B110AA-DN2 → NA B110AA-DMK

To order a product with M12 bottom connector, replace DN2 with SMK in the codes shown above. Example:
NA B110AA-DN2 → NA B110AA-SMK

To order a product with AMP connector, replace DN2 with SAK in the codes shown above. Example:
NA B110AA-DN2 → NA B110AA-SAK

All values in the drawings are in mm

Accessories Packs of **10 pcs.**

Article	Description
VN DT1F	Spacer for NA and NF series
VF D16B	Spacer for NB series

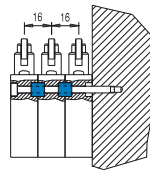

By installing spacers between two switches, it is possible to have 2 or more pre-wired switches, preventing them from slipping.

M12 female connectors with cable For details see page 198

Technical data:

- Polyurethane connector body
- Class 6 copper conductors acc. to IEC 60228 - mobile installation
- Gold-plated contacts (resistance < 5 mΩ)
- Self-locking ring nut
- High flexibility cable with PVC sheath suitable to be used in drag chains, acc. to IEC 60332-3 and CEI 20-22II. With polyurethane sheath on request.

Code structure **Attention!** The feasibility of a code number does not mean the effective availability of a product. Please contact our sales office.

VF CA4PD3M

No. of poles	
4	4 poles
5	5 poles
8	8 poles
12	12 poles

Cable sheath	
P	PVC (standard)
U	PUR

Connector type	
D	straight (standard)
G	angled

Connection type		No. of poles			
M	M12x1				
Cable length (L)		4	5	8	12
1	1 metre				
2	2 metres				
3	3 metres (standard)	•	•		
4	4 metres				
5	5 metres (standard)	•	•	•	•
...					
0	10 metres (standard)	•	•	•	•

Other lengths on request

Stock items

- VF CA4PD3M
- VF CA4PD5M
- VF CA4PD0M
- VF CA5PD3M
- VF CA5PD5M
- VF CA5PD0M
- VF CA8PD5M
- VF CA8PD0M
- VF CA12PD5M
- VF CA12PD0M

Attention! No stock items, minimum order quantity 100 pcs.

Field wireable M12 female connectors

General data

Technopolymer connector body
 Gold-plated contacts
 Screw terminals for cable screw fittings
 Max. operating voltages 250 Vac/dc (4 and 5-pole)
 30 Vac/dc (8-pole)
 Maximum current 4 A
 Protection degree IP67 acc. to EN 60529
 Ambient temperature -25°C ... +85°C
 Wire cross-section 0.25 mm² (24 AWG) ... 0.5 mm² (20 AWG)

Article	Description	no. of poles
VF CBMP4DM04	Field wireable M12 female connector, straight, for Ø 4 ... 6.5 mm multipolar cables	4
VF CBMP5DM04	Field wireable M12 female connector, straight, for Ø 4 ... 6.5 mm multipolar cables	5
VF CBMP8DM04	Field wireable M12 female connector, straight, for Ø 4 ... 7 mm multipolar cables	8

Items with code on **green** background are stock items

→ The 2D and 3D files are available at www.pizzato.com

Selection diagram for item combinations of the NF series

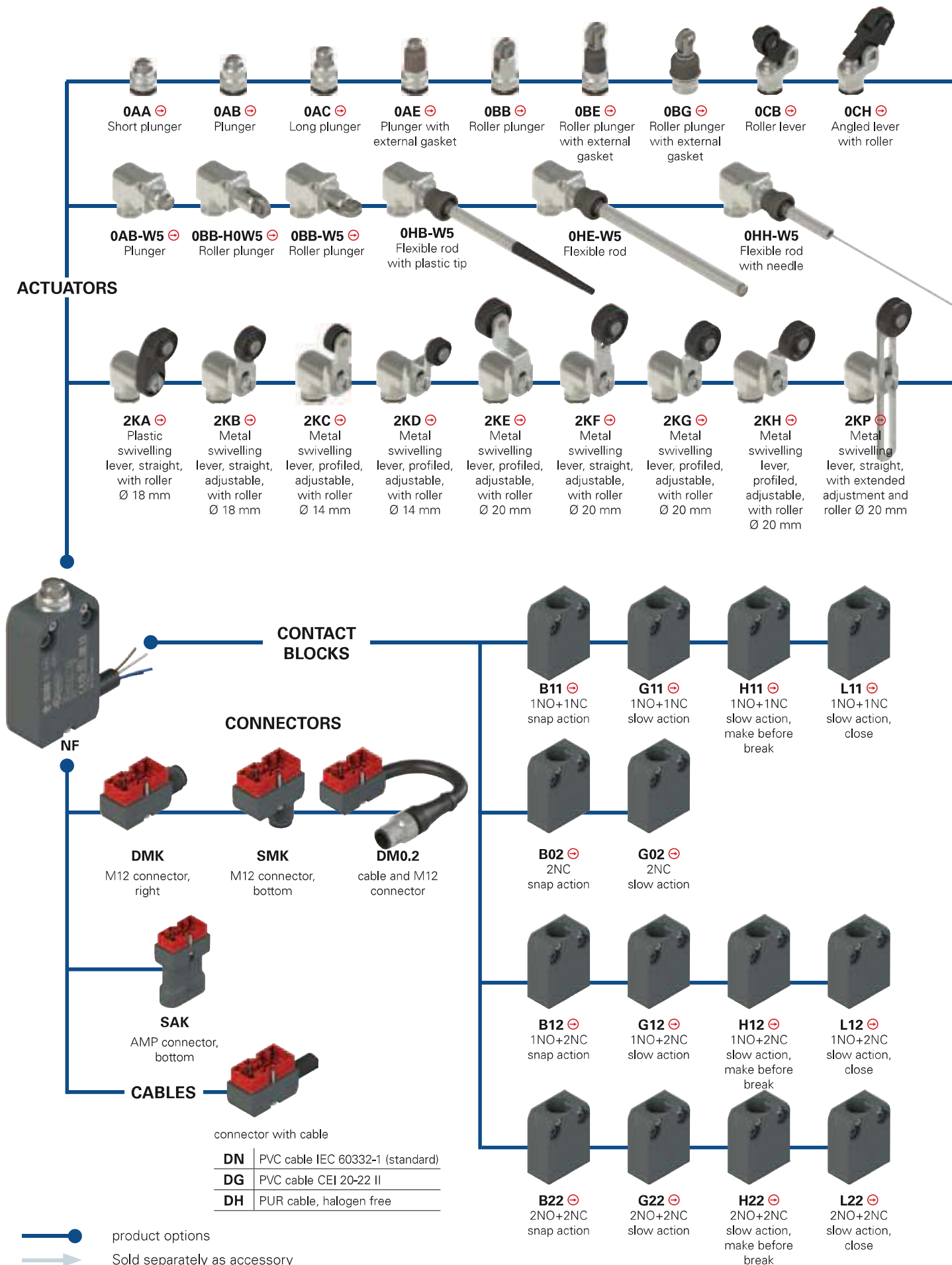

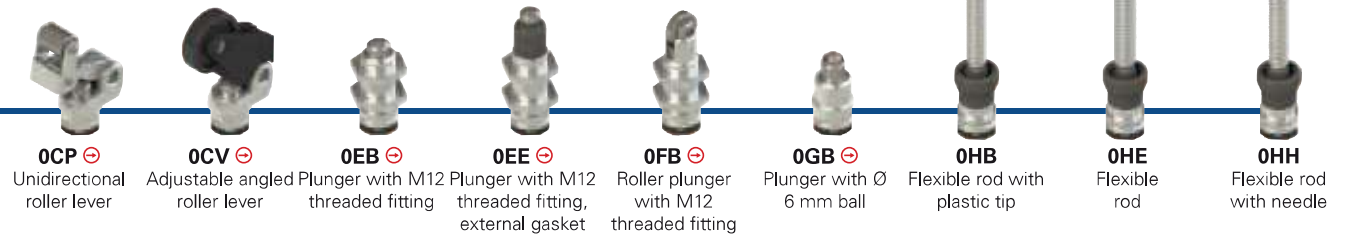

OCP ⊖ Unidirectional roller lever
OCV ⊖ Adjustable angled roller lever
OEB ⊖ Plunger with M12 threaded fitting
OEE ⊖ Plunger with M12 threaded fitting, external gasket
OFB ⊖ Roller plunger with M12 threaded fitting
OGB ⊖ Plunger with Ø 6 mm ball
OHB Flexible rod with plastic tip
OHE Flexible rod
OHH Flexible rod with needle



2LB Metal swivelling lever with stainless steel rod 3 x 3 x 125 mm, adjustable
2LE Metal swivelling lever with stainless steel rod Ø 3 x 125 mm, adjustable
2LH Metal swivelling lever with glass fibre rod Ø 6 x 200 mm, adjustable
2LL Metal swivelling lever with flexible rod, adjustable
2LP ⊖ Metal swivelling lever with porcelain roll, adjustable
200 ⊖ Metal head for swivelling lever actuators

SEPARATE ACTUATORS
See page 135

Code structure **Attention!** The feasibility of a code number does not mean the effective availability of a product. Please contact our sales office.

article options
NF B110AB-DN2 GR7T6W5

<p>Housing</p> <p>NF technopolymer, hole spacing 20 mm</p> <p>Contact block</p> <p>B11 1NO+1NC, snap action (standard) B02 2NC, snap action (standard) B12 1NO+2NC, snap action (standard) B22 2NO+2NC, snap action (standard) G11 1NO+1NC, slow action (standard) G02 2NC, slow action (standard) G12 1NO+2NC, slow action (standard) G22 2NO+2NC, slow action H11 1NO+1NC, slow action, make before break H12 1NO+2NC, slow action, make before break H22 2NO+2NC, slow action, make before break L11 1NO+1NC, slow action, close L12 1NO+2NC, slow action, close L22 2NO+2NC, slow action, close</p> <p>Other contact blocks on request.</p> <p>Actuator heads</p> <p>0 without head 2 head for swivelling lever actuators</p> <p>Actuators</p> <p>AA short plunger AB plunger </p> <p>Output direction</p> <p>D cable or connector, right S connector, bottom</p>	<p>Redirection</p> <p>without redirection W5 90° redirection</p> <p>Ambient temperature</p> <p>-25°C ... +80°C (standard) T6 -40 °C ... +80 °C</p> <p>Rollers</p> <p>standard roller R30 stainless steel Ø 10.6 mm R29 stainless steel Ø 13 mm R18 technopolymer, Ø 14 mm R23 stainless steel Ø 14 mm R7 technopolymer, Ø 18 mm R22 technopolymer, Ø 20 mm R24 stainless steel Ø 20 mm R19 technopolymer, Ø 22 mm R25 technopolymer, Ø 35 mm</p> <p>Contact type</p> <p>silver contacts (standard) G silver contacts, 1 µm gold coating</p> <p>Connection type</p> <p>0.2 cable, length: 0.2 m with M12 connector (available for DM0.2 versions only) 2 cable, length: 2 m (standard) 5 cable, length 5 m (other cable lengths available on request) K integrated connector</p> <p>Cable or connector type</p> <p>N PVC cable IEC 60332-1 (standard) G PVC cable CEI 20-22 II H PUR cable, halogen free M M12 connector A AMP Superseal 1.5 connector</p>
--	---



Main features

- Technopolymer housing, right or bottom cable output
- Protection degrees IP67 and IP69K
- 2 types of integrated cable available
- Versions with M12 connector suitable for safety applications ⊕
- Versions with AMP connector
- 14 contact blocks available
- 37 actuators available

Quality marks:



IMQ approval:	CA02.04562
UL approval:	E131787
CCC approval:	2013010305653520
EAC approval:	RU C-IT.A.135.B.00454

Technical data

Housing

Housing made of glass fibre reinforced technopolymer, self-extinguishing, shock-proof and with double insulation □.

Versions with integrated cable, standard length 2 m. Other lengths 0.5 ... 10 m or special cables available on request.

Versions with integrated M12 connector.

Versions with 0.2 m cable length and M12 connector, other lengths 0.1 ... 3 m available on request

Protection degree:

IP67 acc. to EN 60529
IP69K acc. to ISO 20653
(Protect the cables from direct high-pressure and high-temperature jets)

Corrosion resistance in saline mist: ≥ 300 hours in NSS acc. to ISO 9227

General data

Ambient temperature for switches without cable: -25°C ... + 80°C (standard)
-40°C ... + 80°C (extended T6)

Ambient temperature for switches with cable: See table on page 128

Max. actuation frequency: 3600 operating cycles/hour

Mechanical endurance: 20 million operating cycles

Mounting position: any

Safety parameter B_{10D} : 40,000,000 for NC contacts

Mechanical interlock, not coded: type 1 acc. to EN ISO 14119

Tightening torques for installation: see page 211-222

Electrical data

Rated impulse withstand voltage (U_{imp}): 4 kV

Conditional short circuit current: 1000 A acc. to EN 60947-5-1

Pollution degree: 3

In compliance with standards:

IEC 60947-5-1, EN 60947-5-1, IEC 60204-1, EN 60204-1, EN ISO 14119, EN ISO 12100, EN 60529, ISO 20653, UL 508, CSA 22.2 No.14.

Compliance with the requirements of:

Low Voltage Directive 2014/35/EU, EMC Directive 2014/30/EU.

Positive contact opening in conformity with standards:

IEC 60947-5-1, EN 60947-5-1.

⚠ Installation for safety applications:

Use only switches marked with the symbol ⊕ next to the product code. Always connect the safety circuit to the **NC contacts** (normally closed contacts: see "Internal cable wiring" on page 128) as required by **EN ISO 14119, paragraph 5.4** for specific interlock applications and **EN ISO 13849-2 tables D3** (well-tries components) and **D.8** (failure exclusions) for safety applications in general. Actuate the switch **at least up to the positive opening travel** shown in the travel diagrams on page 220. Actuate the switch **at least with the positive opening force**, reported in brackets below each article, next to the actuating force value. All applicable standards must be respected too.

⚠ **If not expressly indicated in this chapter, for correct installation and utilization of all articles see the instructions given on pages 211 to 222.**

⚠ **Important: Switch off the circuit voltage before disconnecting the connector from the switch. The connector is not suitable for separation of electrical loads.**

Features approved by IMQ

Rated insulation voltage (U):	250 Vac
Conventional free air thermal current (I_n):	10 A (1-2 contacts) / 6 A (2-3 contacts) / 4 A (4 contacts or 4-pole M12 connector)
Protection against short circuits (fuse):	10 A (1-2 contacts) / 6 A (2-3 contacts) / 4 A (4 contacts or 4-pole M12 connector) type gG
Rated impulse withstand voltage (U_{imp}):	4 kV
Protection degree of the housing:	IP67
MA terminals (crimped terminals)	
Pollution degree:	3
Utilization category:	AC15 / DC13 (with connector)
Operating voltage (U_g):	250 Vac (50 Hz) / 24 Vdc (with connector)
Operating current (I_g):	3 A / 2 A (with connector)

Forms of the contact element: X, Y, X+Y, X+X, Y+Y, Y+Y+X, X+X+Y, X+X+Y+Y, Zb

Positive opening of contacts on contact blocks B01, B11, B02, B12, B21, B22, G01, G11, G02, G12, G21, G22, L01, L11, L02, L12, L21, L22, H01, H11, H02, H12, H21, H22

In compliance with standards: EN 60947-1, EN 60947-5-1 + A1:2009, fundamental requirements of the Low Voltage Directive 2014/35/EU.

Please contact our technical department for the list of approved products.

Features approved by UL

Utilization categories	R300 pilot duty (28 VA, 125-250 Vdc) B300 pilot duty (360 VA, 120-240 Vac) (1-2-3 cont.) C300 pilot duty (180 VA, 120-240 Vac) (4 cont.)
Housing features type 1, 4X "indoor use only"; 12.	
Housing features for the version with 1-2 contacts and type N cable	Type 1, 4X "indoor use only"
In compliance with standard:	UL 508, CSA 22.2 No.14

Please contact our technical department for the list of approved products.



Ambient temperatures for switches with cable and electrical data

Connection type	Output with cable						Output with M12 connector		Output with AMP connector
	2 contacts			3 contacts	4 contacts		2 contacts	3 or 4 contacts	2 contacts
Cable or connector type	N	G	H	N	N	H	M12 connector, 5-pole	M12 connector, 8-pole	AMP Superseal 1.5 connector
Conductors	4x0,75 mm ²	4x0,75 mm ²	4x0,75 mm ²	6x0,5 mm ²	8x0,34 mm ²	8x0,34 mm ²	4x0,25 mm ²	8x0,25mm ²	
Application field	General	General	General, mobile installation	General	General	General, mobile installation	General	General	General
In compliance with standards	05VV-F	05VV-F	05EQ-H	03VV-F	03VV-F	03E7Q-H	03VV-H	03VV-H	/
Sheath	PVC	PVC	PUR HALOGEN FREE	PVC	PVC	PUR HALOGEN FREE	PVC	PVC	/
Self-extinguishing	IEC 60332-1-2 IEC 60332-1-3	IEC 60332-1-2 IEC 60332-1-3 IEC 60332-3 CEI 20-22 II	IEC60332-1-2 IEC60332-1-3	IEC 60332-1-2 IEC 60332-1-3	IEC 60332-1-2 IEC 60332-1-3	IEC60332-1-2 IEC60332-1-3	IEC60332-3 CEI 20-22 II	IEC60332-3 CEI 20-22 II	/
Oil resistant	/	/	UL 758	/	/	UL 758	ISO 6722-1	ISO 6722-1	/
Max. speed	/	/	300m/min	/	/	300m/min	50m/min	50m/min	/
Max. acceleration	/	/	30m/s ²	/	/	30m/s ²	5m/s ²	5m/s ²	/
Minimum bending radius	70 mm	70 mm	70 mm	108 mm	94mm	70 mm	75 mm	90 mm	/
Outer diameter	7 mm	7 mm	7 mm	7 mm	7 mm	7 mm	5 mm	5 mm	/
End stripped	80 mm	80 mm	80 mm	80 mm	80 mm	80 mm	/	/	/
Copper conductors IEC 60228	Class 5	Class 5	Class 6	Class 5	Class 5	Class 6	Class 6	Class 6	/

Ambient temperature with cable extended (T ₆) standard	Cable, fixed installation	-25°C +70°C	-25°C +70°C	-25°C +80°C	-25°C +80°C	-25°C +80°C	-25°C +80°C	-25°C +80°C	-25°C +80°C	/	
	Cable, flexible installation	+5°C +70°C	+5°C +70°C	-25°C +80°C	-5°C +80°C	-5°C +80°C	-25°C +80°C	-25°C +80°C	-25°C +80°C	-25°C +80°C	/
	Cable, mobile installation	/	/	-25°C +80°C	/	/	-25°C +80°C	-15°C +80°C	-15°C +80°C	/	
	Cable, fixed installation	/	/	-40°C +80°C	/	/	-40°C +80°C	/	/	/	
	Cable, flexible installation	/	/	-40°C +80°C	/	/	-40°C +80°C	/	/	/	
	Cable, mobile installation	/	/	-40°C +80°C	/	/	-40°C +80°C	/	/	/	
Electrical data	Thermal current I _{th}	10 A	10 A	10 A	6 A	3 A	3 A	4 A	2 A	10 A	
	Rated insulation voltage U _i	250 Vac	250 Vac	250 Vac	250 Vac	250 Vac	250 Vac	250 Vac 300 Vdc	30 Vac 36 Vdc	250 Vac 300 Vdc	
	Protection against short circuits (fuse)	10 A 500 V type gG	10 A 500 V type gG	10 A 500 V type gG	6 A 500 V type gG	3 A 500 V type gG	3 A 500 V type gG	4 A 500 V type gG	2 A 500 V type gG	10 A 500 V type gG	
	Utilization category DC13	24 V	2 A	2 A	2 A	2 A	2 A	2 A	2 A	2 A	2 A
		125 V	0.4 A	0.4 A	0.4 A	0.4 A	0.4 A	0.4 A	/	/	0.4 A
		250 V	0.3 A	0.3 A	0.3 A	0.3 A	0.3 A	0.3 A	0.3 A	/	0.3 A
	Utilization category AC15	24 V	4 A	4 A	4 A	4 A	3 A	3 A	4 A	2 A	4 A
120 V		4 A	4 A	4 A	4 A	3 A	3 A	4 A	/	4 A	
250 V		4 A	4 A	4 A	4 A	3 A	3 A	4 A	/	4 A	
Approvals	CE cULus IMQ EAC CCC	CE EAC CCC	CE EAC	CE cULus IMQ EAC CCC	CE cULus IMQ EAC CCC	CE EAC	CE cULus IMQ EAC CCC	CE cULus EAC CCC	CE cULus EAC CCC	CE cULus EAC CCC	

Internal cable wiring

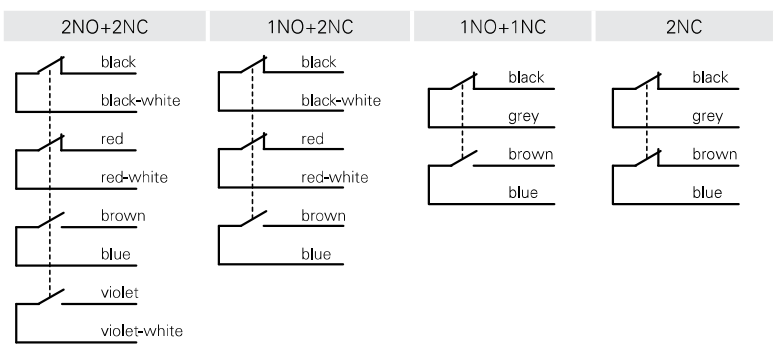

Connector pin assignment

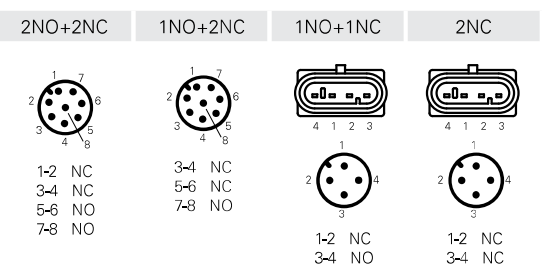

Female connectors see page 198

Contact type:					With external rubber gasket	
R	= snap action					
L	= slow action					
Contact block						
B11	R NF B110AA-DN2	➔ 1NO+1NC	NF B110AB-DN2	➔ 1NO+1NC	NF B110AC-DN2	➔ 1NO+1NC
B02	R NF B020AA-DN2	➔ 2NC	NF B020AB-DN2	➔ 2NC	NF B020AC-DN2	➔ 2NC
B12	R NF B120AA-DN2	➔ 1NO+2NC	NF B120AB-DN2	➔ 1NO+2NC	NF B120AC-DN2	➔ 1NO+2NC
B22	R NF B220AA-DN2	➔ 2NO+2NC	NF B220AB-DN2	➔ 2NO+2NC	NF B220AC-DN2	➔ 2NO+2NC
G11	L NF G110AA-DN2	➔ 1NO+1NC	NF G110AB-DN2	➔ 1NO+1NC	NF G110AC-DN2	➔ 1NO+1NC
G02	L NF G020AA-DN2	➔ 2NC	NF G020AB-DN2	➔ 2NC	NF G020AC-DN2	➔ 2NC
G12	L NF G120AA-DN2	➔ 1NO+2NC	NF G120AB-DN2	➔ 1NO+2NC	NF G120AC-DN2	➔ 1NO+2NC
G22	L NF G220AA-DN2	➔ 2NO+2NC	NF G220AB-DN2	➔ 2NO+2NC	NF G220AC-DN2	➔ 2NO+2NC
Max. speed	page 219 - type 4		page 219 - type 4		page 219 - type 4	
Actuating force	7 N (25 N ➔)		7 N (25 N ➔)		7 N (25 N ➔)	
Travel diagrams	page 220 - group 1		page 220 - group 1		page 220 - group 1	

Contact block		With external rubber gasket		With external rubber gasket		With stainless steel roller on request	
B11	R NF B110BB-DN2	➔ 1NO+1NC	NF B110BE-DN2	➔ 1NO+1NC	NF B110BG-DN2	➔ 1NO+1NC	NF B110CB-DN2
B02	R NF B020BB-DN2	➔ 2NC	NF B020BE-DN2	➔ 2NC	NF B020BG-DN2	➔ 2NC	NF B020CB-DN2
B12	R NF B120BB-DN2	➔ 1NO+2NC	NF B120BE-DN2	➔ 1NO+2NC	NF B120BG-DN2	➔ 1NO+2NC	NF B120CB-DN2
B22	R NF B220BB-DN2	➔ 2NO+2NC	NF B220BE-DN2	➔ 2NO+2NC	NF B220BG-DN2	➔ 2NO+2NC	NF B220CB-DN2
G11	L NF G110BB-DN2	➔ 1NO+1NC	NF G110BE-DN2	➔ 1NO+1NC	NF G110BG-DN2	➔ 1NO+1NC	NF G110CB-DN2
G02	L NF G020BB-DN2	➔ 2NC	NF G020BE-DN2	➔ 2NC	NF G020BG-DN2	➔ 2NC	NF G020CB-DN2
G12	L NF G120BB-DN2	➔ 1NO+2NC	NF G120BE-DN2	➔ 1NO+2NC	NF G120BG-DN2	➔ 1NO+2NC	NF G120CB-DN2
G22	L NF G220BB-DN2	➔ 2NO+2NC	NF G220BE-DN2	➔ 2NO+2NC	NF G220BG-DN2	➔ 2NO+2NC	NF G220CB-DN2
Max. speed	page 219 - type 2		page 219 - type 5		page 219 - type 5		page 219 - type 3
Actuating force	7 N (25 N ➔)		7 N (25 N ➔)		7 N (25 N ➔)		5 N (25 N ➔)
Travel diagrams	page 220 - group 1		page 220 - group 1		page 220 - group 1		page 220 - group 2

M12 connector, right

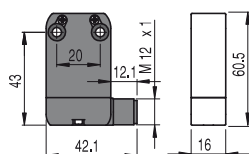

M12 connector, bottom

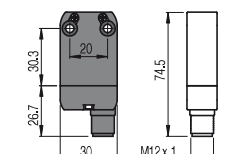

AMP Superseal 1.5 connector

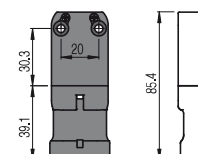

To order a product with M12 right connector, replace DN2 with DMK in the codes shown above.
Example:
NF B110AA-DN2 → NF B110AA-DMK

To order a product with M12 bottom connector, replace DN2 with SMK in the codes shown above.
Example:
NF B110AA-DN2 → NF B110AA-SMK

To order a product with AMP connector, replace DN2 with SAK in the codes shown above.
Example:
NF B110AA-DN2 → NF B110AA-SAK

All values in the drawings are in mm

Items with code on green background are stock items

Accessories See page 197

→ The 2D and 3D files are available at www.pizzato.com



Contact type: R = snap action L = slow action	With stainless steel roller on request	Unidirectional operation	Secured only by means of threaded head	
		It does not switch It switches		
Contact block				
B11 R	NF B110CH-DN2 1NO+1NC	NF B110CP-DN2 1NO+1NC	NF B110CV-DN2 1NO+1NC	NF B110EB-DN2 1NO+1NC
B02 R	NF B020CH-DN2 2NC	NF B020CP-DN2 2NC	NF B020CV-DN2 2NC	NF B020EB-DN2 2NC
B12 R	NF B120CH-DN2 1NO+2NC	NF B120CP-DN2 1NO+2NC	NF B120CV-DN2 1NO+2NC	NF B120EB-DN2 1NO+2NC
B22 R	NF B220CH-DN2 2NO+2NC	NF B220CP-DN2 2NO+2NC	NF B220CV-DN2 2NO+2NC	NF B220EB-DN2 2NO+2NC
G11 L	NF G110CH-DN2 1NO+1NC	NF G110CP-DN2 1NO+1NC	NF G110CV-DN2 1NO+1NC	NF G110EB-DN2 1NO+1NC
G02 L	NF G020CH-DN2 2NC	NF G020CP-DN2 2NC	NF G020CV-DN2 2NC	NF G020EB-DN2 2NC
G12 L	NF G120CH-DN2 1NO+2NC	NF G120CP-DN2 1NO+2NC	NF G120CV-DN2 1NO+2NC	NF G120EB-DN2 1NO+2NC
G22 L	NF G220CH-DN2 2NO+2NC	NF G220CP-DN2 2NO+2NC	NF G220CV-DN2 2NO+2NC	NF G220EB-DN2 2NO+2NC
Max. speed	page 219 - type 3	page 219 - type 3	page 219 - type 3	page 219 - type 4
Actuating force	5 N (25 N)	3 N (25 N)	3 N (25 N)	7 N (25 N)
Travel diagrams	page 220 - group 2	page 220 - group 6	page 220 - group 3	page 220 - group 1

Contact block	Secured only by means of threaded head With external rubber gasket	Secured only by means of threaded head	Plunger with Ø 6 mm ball	With external rubber gasket
B11 R	NF B110EE-DN2 1NO+1NC	NF B110FB-DN2 1NO+1NC	NF B110GB-DN2 1NO+1NC	NF B110HB-DN2 1NO+1NC
B02 R	NF B020EE-DN2 2NC	NF B020FB-DN2 2NC	NF B020GB-DN2 2NC	NF B020HB-DN2 2NC
B12 R	NF B120EE-DN2 1NO+2NC	NF B120FB-DN2 1NO+2NC	NF B120GB-DN2 1NO+2NC	NF B120HB-DN2 1NO+2NC
B22 R	NF B220EE-DN2 2NO+2NC	NF B220FB-DN2 2NO+2NC	NF B220GB-DN2 2NO+2NC	NF B220HB-DN2 2NO+2NC
G11 L	NF G110EE-DN2 1NO+1NC	NF G110FB-DN2 1NO+1NC	NF G110GB-DN2 1NO+1NC	
G02 L	NF G020EE-DN2 2NC	NF G020FB-DN2 2NC	NF G020GB-DN2 2NC	NF G020HB-DN2 2NC
G12 L	NF G120EE-DN2 1NO+2NC	NF G120FB-DN2 1NO+2NC	NF G120GB-DN2 1NO+2NC	
G22 L	NF G220EE-DN2 2NO+2NC	NF G220FB-DN2 2NO+2NC	NF G220GB-DN2 2NO+2NC	
Max. speed	page 219 - type 4	page 219 - type 2	page 219 - type 2	1 m/s
Actuating force	7 N (25 N)	7 N (25 N)	7 N (25 N)	0.03 Nm
Travel diagrams	page 220 - group 1	page 220 - group 1	page 220 - group 1	page 220 - group 4

Cable and M12 connector

All values in the drawings are in mm

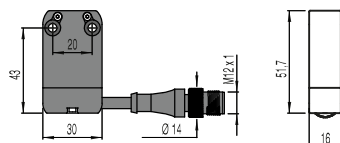

To order a product with cable and M12 connector:
 replace DN2 with DM0.2 in the codes shown above.
 Example:
 NF B110AA-DN2 → NF B110AA-DM0.2

Contact type:
R = snap action
L = slow action

Contact block

	With external rubber gasket		With external rubber gasket		With stainless steel roller on request		With stainless steel roller on request		
B11	R	NF B110HE-DN2	1NO+1NC	NF B110HH-DN2	1NO+1NC	NF B112KA-DN2	➔ 1NO+1NC	NF B112KB-DN2	➔ 1NO+1NC
B02	R	NF B020HE-DN2	2NC	NF B020HH-DN2	2NC	NF B022KA-DN2	➔ 2NC	NF B022KB-DN2	➔ 2NC
B12	R	NF B120HE-DN2	1NO+2NC	NF B120HH-DN2	1NO+2NC	NF B122KA-DN2	➔ 1NO+2NC	NF B122KB-DN2	➔ 1NO+2NC
B22	R	NF B220HE-DN2	2NO+2NC	NF B220HH-DN2	2NO+2NC	NF B222KA-DN2	➔ 2NO+2NC	NF B222KB-DN2	➔ 2NO+2NC
G11	L					NF G112KA-DN2	➔ 1NO+1NC	NF G112KB-DN2	➔ 1NO+1NC
G02	L	NF G020HE-DN2	2NC	NF G020HH-DN2	2NC	NF G022KA-DN2	➔ 2NC	NF G022KB-DN2	➔ 2NC
G12	L					NF G122KA-DN2	➔ 1NO+2NC	NF G122KB-DN2	➔ 1NO+2NC
G22	L					NF G222KA-DN2	➔ 2NO+2NC	NF G222KB-DN2	➔ 2NO+2NC
Max. speed	1 m/s		1 m/s		page 219 - type 1		page 219 - type 1		
Actuating force	0.07 Nm		0.03 Nm		0.07 Nm (0.25 Nm ➔)		0.07 Nm (0.25 Nm ➔)		
Travel diagrams	page 220 - group 4		page 220 - group 4		page 220 - group 5		page 220 - group 5		

	With stainless steel roller on request		With stainless steel roller on request		With stainless steel roller on request		With stainless steel roller on request		
B11	R	NF B112KC-DN2	➔ 1NO+1NC	NF B112KD-DN2	➔ 1NO+1NC	NF B112KE-DN2	➔ 1NO+1NC	NF B112KF-DN2	➔ 1NO+1NC
B02	R	NF B022KC-DN2	➔ 2NC	NF B022KD-DN2	➔ 2NC	NF B022KE-DN2	➔ 2NC	NF B022KF-DN2	➔ 2NC
B12	R	NF B122KC-DN2	➔ 1NO+2NC	NF B122KD-DN2	➔ 1NO+2NC	NF B122KE-DN2	➔ 1NO+2NC	NF B122KF-DN2	➔ 1NO+2NC
B22	R	NF B222KC-DN2	➔ 2NO+2NC	NF B222KD-DN2	➔ 2NO+2NC	NF B222KE-DN2	➔ 2NO+2NC	NF B222KF-DN2	➔ 2NO+2NC
G11	L	NF G112KC-DN2	➔ 1NO+1NC	NF G112KD-DN2	➔ 1NO+1NC	NF G112KE-DN2	➔ 1NO+1NC	NF G112KF-DN2	➔ 1NO+1NC
G02	L	NF G022KC-DN2	➔ 2NC	NF G022KD-DN2	➔ 2NC	NF G022KE-DN2	➔ 2NC	NF G022KF-DN2	➔ 2NC
G12	L	NF G122KC-DN2	➔ 1NO+2NC	NF G122KD-DN2	➔ 1NO+2NC	NF G122KE-DN2	➔ 1NO+2NC	NF G122KF-DN2	➔ 1NO+2NC
G22	L	NF G222KC-DN2	➔ 2NO+2NC	NF G222KD-DN2	➔ 2NO+2NC	NF G222KE-DN2	➔ 2NO+2NC	NF G222KF-DN2	➔ 2NO+2NC
Max. speed	page 219 - type 1		page 219 - type 1		page 219 - type 1		page 219 - type 1		
Actuating force	0.07 Nm (0.25 Nm ➔)		0.07 Nm (0.25 Nm ➔)		0.07 Nm (0.25 Nm ➔)		0.07 Nm (0.25 Nm ➔)		
Travel diagrams	page 220 - group 5		page 220 - group 5		page 220 - group 5		page 220 - group 5		

M12 connector, right

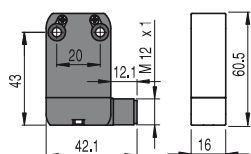

M12 connector, bottom

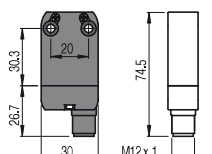

AMP Superseal 1.5 connector

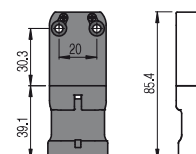

To order a product with M12 right connector, replace DN2 with DMK in the codes shown above.
 Example:
 NF B110AA-DN2 → NF B110AA-DMK

To order a product with M12 bottom connector, replace DN2 with SMK in the codes shown above.
 Example:
 NF B110AA-DN2 → NF B110AA-SMK

To order a product with AMP connector, replace DN2 with SAK in the codes shown above.
 Example:
 NF B110AA-DN2 → NF B110AA-SAK

All values in the drawings are in mm



Contact type:	With stainless steel roller on request	With stainless steel roller on request	With stainless steel roller on request	Square rod, 3x3 mm, stainless steel
R = snap action L = slow action				
Contact block				
B11	R NF B112KG-DN2 → 1NO+1NC	NF B112KH-DN2 → 1NO+1NC	NF B112KP-DN2 → 1NO+1NC	NF B112LB-DN2 1NO+1NC
B02	R NF B022KG-DN2 → 2NC	NF B022KH-DN2 → 2NC	NF B022KP-DN2 → 2NC	NF B022LB-DN2 2NC
B12	R NF B122KG-DN2 → 1NO+2NC	NF B122KH-DN2 → 1NO+2NC	NF B122KP-DN2 → 1NO+2NC	NF B122LB-DN2 1NO+2NC
B22	R NF B222KG-DN2 → 2NO+2NC	NF B222KH-DN2 → 2NO+2NC	NF B222KP-DN2 → 2NO+2NC	NF B222LB-DN2 2NO+2NC
G11	L NF G112KG-DN2 → 1NO+1NC	NF G112KH-DN2 → 1NO+1NC	NF G112KP-DN2 → 1NO+1NC	NF G112LB-DN2 1NO+1NC
G02	L NF G022KG-DN2 → 2NC	NF G022KH-DN2 → 2NC	NF G022KP-DN2 → 2NC	NF G022LB-DN2 2NC
G12	L NF G122KG-DN2 → 1NO+2NC	NF G122KH-DN2 → 1NO+2NC	NF G122KP-DN2 → 1NO+2NC	NF G122LB-DN2 1NO+2NC
G22	L NF G222KG-DN2 → 2NO+2NC	NF G222KH-DN2 → 2NO+2NC	NF G222KP-DN2 → 2NO+2NC	NF G222LB-DN2 2NO+2NC
Max. speed	page 219 - type 1	page 219 - type 1	page 219 - type 1	1,5 m/s
Actuating force	0,07 Nm (0,25 Nm →)	0,07 Nm (0,25 Nm →)	0,07 Nm (0,25 Nm →)	0,07 Nm
Travel diagrams	page 220 - group 5	page 220 - group 5	page 220 - group 5	page 220 - group 5

Contact block	Round rod, Ø 3 mm, stainless steel	Glass fibre rod	Porcelain roller
B11	R NF B112LE-DN2 1NO+1NC	NF B112LH-DN2 1NO+1NC	NF B112LL-DN2 1NO+1NC
B02	R NF B022LE-DN2 2NC	NF B022LH-DN2 2NC	NF B022LL-DN2 2NC
B12	R NF B122LE-DN2 1NO+2NC	NF B122LH-DN2 1NO+2NC	NF B122LL-DN2 1NO+2NC
B22	R NF B222LE-DN2 2NO+2NC	NF B222LH-DN2 2NO+2NC	NF B222LL-DN2 2NO+2NC
G11	L NF G112LE-DN2 1NO+1NC	NF G112LH-DN2 1NO+1NC	NF G112LL-DN2 1NO+1NC
G02	L NF G022LE-DN2 2NC	NF G022LH-DN2 2NC	NF G022LL-DN2 2NC
G12	L NF G122LE-DN2 1NO+2NC	NF G122LH-DN2 1NO+2NC	NF G122LL-DN2 1NO+2NC
G22	L NF G222LE-DN2 2NO+2NC	NF G222LH-DN2 2NO+2NC	NF G222LL-DN2 2NO+2NC
Max. speed	1,5 m/s	1,5 m/s	1,5 m/s
Actuating force	0,07 Nm	0,07 Nm	0,07 Nm
Travel diagrams	page 220 - group 5	page 220 - group 5	page 220 - group 5

Cable and M12 connector

All values in the drawings are in mm

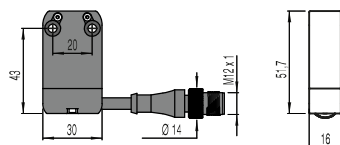

To order a product with cable and M12 connector:
 replace DN2 with DM0.2 in the codes shown above.
 Example:
 NF B110AA-DN2 → NF B110AA-DM0.2

Contact type:

R = snap action
L = slow action

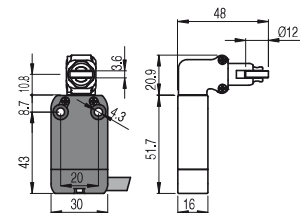
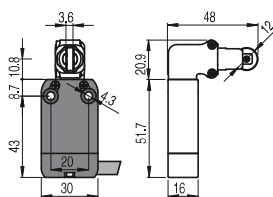
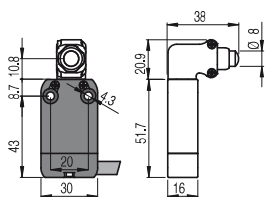

Contact block

B11	R	NF B110AB-DN2W5	↻ 1NO+1NC	NF B110BB-DN2H0W5	↻ 1NO+1NC	NF B110BB-DN2W5	↻ 1NO+1NC
B02	R	NF B020AB-DN2W5	↻ 2NC	NF B020BB-DN2H0W5	↻ 2NC	NF B020BB-DN2W5	↻ 2NC
B12	R	NF B120AB-DN2W5	↻ 1NO+2NC	NF B120BB-DN2H0W5	↻ 1NO+2NC	NF B120BB-DN2W5	↻ 1NO+2NC
B22	R	NF B220AB-DN2W5	↻ 2NO+2NC	NF B220BB-DN2H0W5	↻ 2NO+2NC	NF B220BB-DN2W5	↻ 2NO+2NC
G11	L	NF G110AB-DN2W5	↻ 1NO+1NC	NF G110BB-DN2H0W5	↻ 1NO+1NC	NF G110BB-DN2W5	↻ 1NO+1NC
G02	L	NF G020AB-DN2W5	↻ 2NC	NF G020BB-DN2H0W5	↻ 2NC	NF G020BB-DN2W5	↻ 2NC
G12	L	NF G120AB-DN2W5	↻ 1NO+2NC	NF G120BB-DN2H0W5	↻ 1NO+2NC	NF G120BB-DN2W5	↻ 1NO+2NC
G22	L	NF G220AB-DN2W5	↻ 2NO+2NC	NF G220BB-DN2H0W5	↻ 2NO+2NC	NF G220BB-DN2W5	↻ 2NO+2NC
Max. speed		page 219 - type 4		page 219 - type 2		page 219 - type 2	
Actuating force		9.5 N (25 N ↻)		9.5 N (25 N ↻)		9.5 N (25 N ↻)	
Travel diagrams		page 220 - group 1		page 220 - group 1		page 220 - group 1	

With external gasket

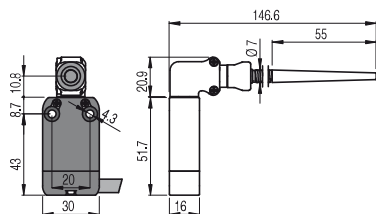

With external gasket

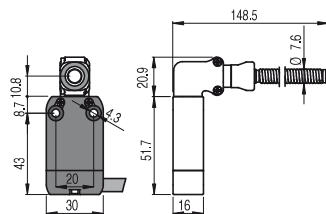

With external gasket

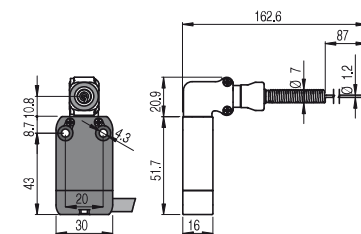

Contact block

B11	R	NF B110HB-DN2W5	1NO+1NC	NF B110HE-DN2W5	1NO+1NC	NF B110HH-DN2W5	1NO+1NC
B02	R	NF B020HB-DN2W5	2NC	NF B020HE-DN2W5	2NC	NF B020HH-DN2W5	2NC
B12	R	NF B120HB-DN2W5	1NO+2NC	NF B120HE-DN2W5	1NO+2NC	NF B120HH-DN2W5	1NO+2NC
B22	R	NF B220HB-DN2W5	2NO+2NC	NF B220HE-DN2W5	2NO+2NC	NF B220HH-DN2W5	2NO+2NC
G11	L						
G02	L	NF G020HB-DN2W5	2NC	NF G020HE-DN2W5	2NC	NF G020HH-DN2W5	2NC
G12	L						
G22	L						
Max. speed		1 m/s		1 m/s		1 m/s	
Actuating force		0.08 Nm		0.12 Nm		0.08 Nm	
Travel diagrams		page 220 - group 4		page 220 - group 4		page 220 - group 4	

M12 connector, right

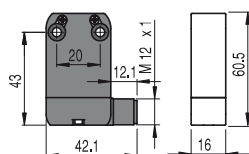

M12 connector, bottom

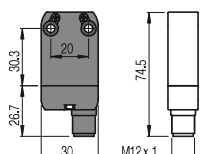

AMP Superseal 1.5 connector

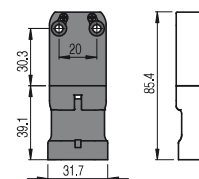

To order a product with M12 right connector, replace DN2 with DMK in the codes shown above.
 Example:
 NF B110AA-DN2 → NF B110AA-DMK

To order a product with M12 bottom connector, replace DN2 with SMK in the codes shown above.
 Example:
 NF B110AA-DN2 → NF B110AA-SMK

To order a product with AMP connector, replace DN2 with SAK in the codes shown above. Example:
 NF B110AA-DN2 → NF B110AA-SAK

All values in the drawings are in mm

Accessories Packs of **10 pcs.**

Article	Description
VN DT1F	Spacer for NA and NF series
VF D16B	Spacer for NB series

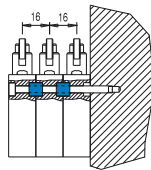

By installing spacers between two switches, it is possible to have 2 or more pre-wired switches, preventing them from slipping.

M12 female connectors with cable For details see page 198

Technical data:

- Polyurethane connector body
- Class 6 copper conductors acc. to IEC 60228 - mobile installation
- Gold-plated contacts (resistance < 5 mΩ)
- Self-locking ring nut
- High flexibility cable with PVC sheath suitable to be used in drag chains, acc. to IEC 60332-3 and CEI 20-22II. With polyurethane sheath on request

Code structure **Attention!** The feasibility of a code number does not mean the effective availability of a product. Please contact our sales office.

VF CA4PD3M

No. of poles	
4	4 poles
5	5 poles
8	8 poles
12	12 poles

Cable sheath	
P	PVC (standard)
U	PUR

Connector type	
D	straight (standard)
G	angled

Connection type	
M	M12x1

Cable length (L)	No. of poles			
	4	5	8	12
1	1 metre			
2	2 metres			
3	3 metres (standard)	•	•	
4	4 metres			
5	5 metres (standard)	•	•	•
...				
0	10 metres (standard)	•	•	•

Other lengths on request

Stock items

- VF CA4PD3M
- VF CA4PD5M
- VF CA4PD0M
- VF CA5PD3M
- VF CA5PD5M
- VF CA5PD0M
- VF CA8PD5M
- VF CA8PD0M
- VF CA12PD5M
- VF CA12PD0M

Attention! No stock items, minimum order quantity 100 pcs.

Field wireable M12 female connectors

General data

Technopolymer connector body
 Gold-plated contacts
 Screw terminals for cable screw fittings

Max. operating voltages	250 Vac/dc (4 and 5-pole) 30 Vac/dc (8-pole)
Maximum current	4 A
Protection degree	IP67 acc. to EN 60529
Ambient temperature	-25°C ... +85°C
Wire cross-section	0.25 mm ² (24 AWG) ... 0.5 mm ² (20 AWG)

Article	Description	no. of poles
VF CBMP4DM04	Field wireable M12 female connector, straight, for Ø 4 ... 6.5 mm multipolar cables	4
VF CBMP5DM04	Field wireable M12 female connector, straight, for Ø 4 ... 6.5 mm multipolar cables	5
VF CBMP8DM04	Field wireable M12 female connector, straight, for Ø 4 ... 7 mm multipolar cables	8

Items with code on **green** background are stock items

→ The 2D and 3D files are available at www.pizzato.com

Selection diagram for item combinations of the NA - NB - NF series

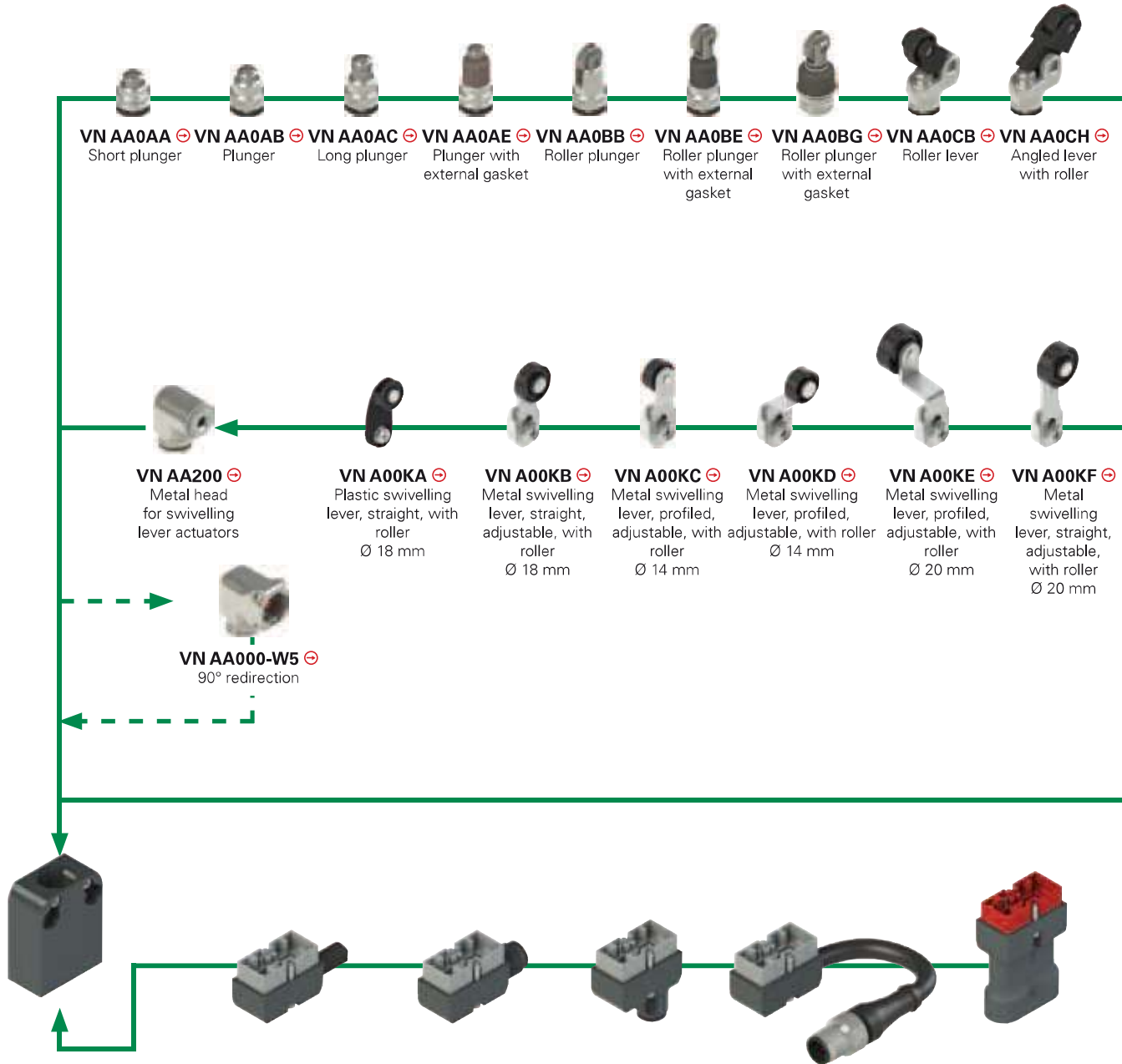

METAL housing, NA hole spacing 20 mm
NA B11000 ⊕ 1NO+1NC [R]
NA G11000 ⊕ 1NO+1NC [L]
NA L11000 ⊕ 1NO+1NC [LA]
NA H11000 ⊕ 1NO+1NC [LO]
NA B02000 ⊕ 2NC [R]
NA G02000 ⊕ 2NC [L]
NA B20000 ⊕ 2NO [R]
NA G20000 ⊕ 2NO [L]
NA B12000 ⊕ 1NO+2NC [R]
NA G12000 ⊕ 1NO+2NC [L]
NA L12000 ⊕ 1NO+2NC [LA]
NA H12000 ⊕ 1NO+2NC [LO]
NA B22000 ⊕ 2NO+2NC [R]
NA G22000 ⊕ 2NO+2NC [L]
NA L22000 ⊕ 2NO+2NC [LA]
NA H22000 ⊕ 2NO+2NC [LO]

Metal connector with cable	Cable length (m)
VN CM11DN2	2
VN CM11DN5	5
VN CM02DN2	2
VN CM02DN5	5
/	/
/	/
VN CM12DN2	2
VN CM12DN5	5
VN CM22DN2	2
VN CM22DN5	5

M12 metal connector, right
VN CM11DMK
VN CM02DMK
VN CM20DMK
VN CM12DMK
VN CM22DMK

M12 metal connector, bottom
VN CM11SMK
VN CM02SMK
VN CM20SMK
VN CM12SMK
VN CM22SMK

Metal connector with cable and M12 connector	Cable length (m)
VN CM11DM0.2	0,2
VN CM02DM0.2	0,2
VN CM20DM0.2	0,2
VN CM12DM0.2	0,2
VN CM22DM0.2	0,2

AMP technopolymer connector, bottom
VN CM11SAK
VN CM02SAK
VN CM20SAK

To order a NB series housing, replace NA with NB in the codes shown above. Example:
NA B11000 → NB B11000

⚠ It is not allowed to install VN CM***** connectors on technopolymer housings

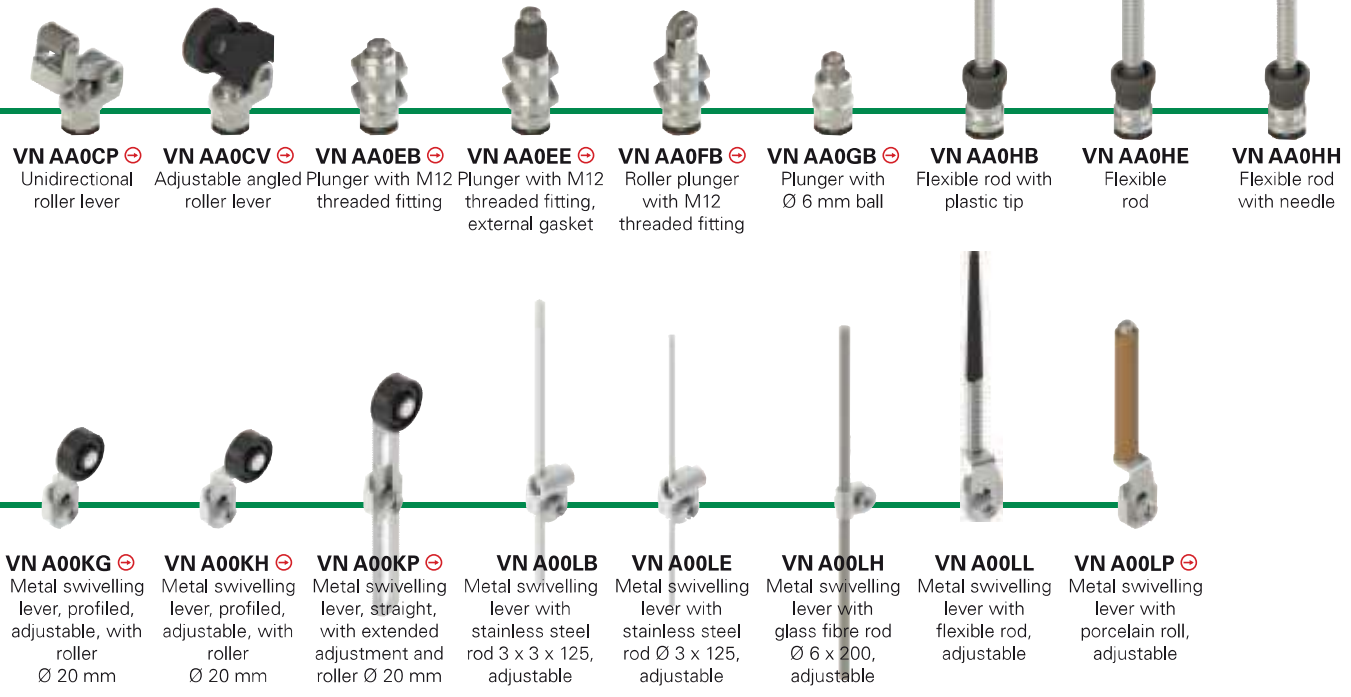

VN AA0CP ⊕ Unidirectional roller lever
VN AA0CV ⊕ Adjustable angled roller lever
VN AA0EB ⊕ Plunger with M12 threaded fitting
VN AA0EE ⊕ Plunger with M12 threaded fitting, external gasket
VN AA0FB ⊕ Roller plunger with M12 threaded fitting
VN AA0GB ⊕ Plunger with Ø 6 mm ball
VN AA0HB Flexible rod with plastic tip
VN AA0HE Flexible rod
VN AA0HH Flexible rod with needle

VN A00KG ⊕ Metal swivelling lever, profiled, adjustable, with roller Ø 20 mm
VN A00KH ⊕ Metal swivelling lever, profiled, adjustable, with roller Ø 20 mm
VN A00KP ⊕ Metal swivelling lever, straight, with extended adjustment and roller Ø 20 mm
VN A00LB Metal swivelling lever with stainless steel rod 3 x 3 x 125, adjustable
VN A00LE Metal swivelling lever with stainless steel rod Ø 3 x 125, adjustable
VN A00LH Metal swivelling lever with glass fibre rod Ø 6 x 200, adjustable
VN A00LL Metal swivelling lever with flexible rod, adjustable
VN A00LP ⊕ Metal swivelling lever with porcelain roll, adjustable

Contact type:
R = snap action
L = slow action
LO = slow action, make before break
LA = slow action, close

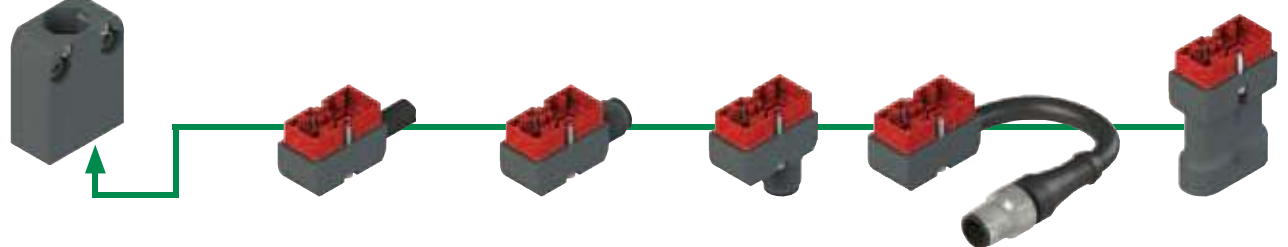

NFTECHNOPOLYMER housing, 20 mm hole spacing	Technopolymer connector with cable	Cable length (m)	M12 technopolymer connector, right	M12 technopolymer connector, bottom	Technopolymer connector with cable and M12 connector	Cable length (m)	AMP technopolymer connector, bottom
NF B11000 ⊕ 1NO+1NC R	VN CP11DN2	2	VN CP11DMK	VN CP11SMK	VN CP11DM0.2	0,2	VN CP11SAK
NF G11000 ⊕ 1NO+1NC L	VN CP11DN5	5					
NF L11000 ⊕ 1NO+1NC LA	VN CP02DN2	2	VN CP02DMK	VN CP02SMK	VN CP02DM0.2	0,2	VN CP02SAK
NF H11000 ⊕ 1NO+1NC LO	VN CP02DN5	5					
NF B20000 ⊕ 2NC R	VN CP20DN2	2	VN CP20DMK	VN CP20SMK	VN CP20DM0.2	0,2	VN CP20SAK
NF G20000 ⊕ 2NC L	VN CP20DN5	5					
NF B12000 ⊕ 1NO+2NC R	VN CP12DN2	2	VN CP22DMK	VN CP22SMK	VN CP22DM0.2	0,2	
NF G12000 ⊕ 1NO+2NC L	VN CP12DN5	5					
NF L12000 ⊕ 1NO+2NC LA	VN CP22DN2	2					
NF H12000 ⊕ 1NO+2NC LO	VN CP22DN5	5					
NF B22000 ⊕ 2NO+2NC R							
NF G22000 ⊕ 2NO+2NC L							
NF L22000 ⊕ 2NO+2NC LA							
NF H22000 ⊕ 2NO+2NC LO							

⚠ It is not allowed to install VN CP***** connectors on metal housings

Housings

All values in the drawings are in mm

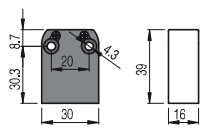
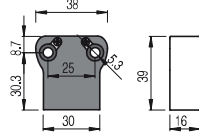
NA metal housings	NB metal housings
	
NA B11000 1NO+1NC R NA G11000 1NO+1NC L NA L11000 1NO+1NC LA NA H11000 1NO+1NC LO NA B12000 1NO+2NC R NA G12000 1NO+2NC L NA L12000 1NO+2NC LA NA H12000 1NO+2NC LO NA B22000 2NO+2NC R NA G22000 2NO+2NC L NA L22000 2NO+2NC LA NA H22000 2NO+2NC LO	NB B11000 1NO+1NC R NB G11000 1NO+1NC L NB L11000 1NO+1NC LA NB H11000 1NO+1NC LO NB B12000 1NO+2NC R NB G12000 1NO+2NC L NB L12000 1NO+2NC LA NB H12000 1NO+2NC LO NB B22000 2NO+2NC R NB G22000 2NO+2NC L NB L22000 2NO+2NC LA NB H22000 2NO+2NC LO

Contact type:
R = snap action
L = slow action
LO = slow action, make before break
LA = slow action, dose

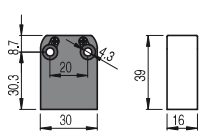

NF technopolymer housings

NF B11000 1NO+1NC R NF G11000 1NO+1NC L NF L11000 1NO+1NC LA NF H11000 1NO+1NC LO NF B12000 1NO+2NC R NF G12000 1NO+2NC L NF L12000 1NO+2NC LA NF H12000 1NO+2NC LO NF B22000 2NO+2NC R NF G22000 2NO+2NC L NF L22000 2NO+2NC LA NF H22000 2NO+2NC LO

Connectors with cable

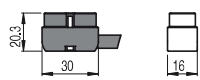
All values in the drawings are in mm

metal connectors for NA and NB housings	Cable length (m)	Cable type N = PVC H = PUR HALOGEN FREE
		
VN CM11DN2 1NO+1NC	2	N
VN CM11DN5 1NO+1NC	5	
VN CM12DN2 1NO+2NC	2	
VN CM12DN5 1NO+2NC	5	
VN CM22DN2 2NO+2NC	2	
VN CM22DN5 2NO+2NC	5	H
VN CM11DH2 1NO+1NC	2	
VN CM11DH5 1NO+1NC	5	
VN CM12DH2 1NO+2NC	2	
VN CM12DH5 1NO+2NC	5	

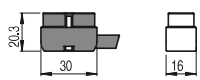
Other cable lengths on request

technopolymer connectors for NF housings	Cable length (m)	Cable type N = PVC H = PUR HALOGEN FREE
		
VN CP11DN2 1NO+1NC	2	N
VN CP11DN5 1NO+1NC	5	
VN CP12DN2 1NO+2NC	2	
VN CP12DN5 1NO+2NC	5	
VN CP22DN2 2NO+2NC	2	
VN CP22DN5 2NO+2NC	5	H
VN CP11DH2 1NO+1NC	2	
VN CP11DH5 1NO+1NC	5	
VN CP22DH2 2NO+2NC	2	
VN CP22DH5 2NO+2NC	5	

M12 or AMP connectors

All values in the drawings are in mm

Important: Always check that the applied electric load is within the voltage and current limits defined for the connectors. See tables on page 118 and 128.

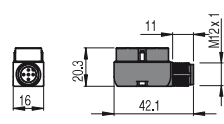
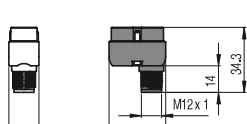
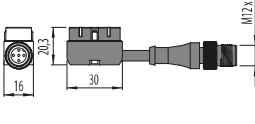
metal connectors for NA and NB housings		
M12 connector, right 	M12 connector, bottom 	with cable and M12 connector 
VN CM11DMK 1NO+1NC	VN CM11SMK 1NO+1NC	VN CM11DM0.2 1NO+1NC
VN CM02DMK 2NC	VN CM02SMK 2NC	VN CM02DM0.2 2NC
VN CM22DMK 2NO+2NC	VN CM22SMK 2NO+2NC	VN CM22DM0.2 2NO+2NC

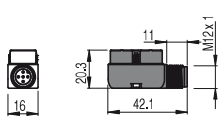
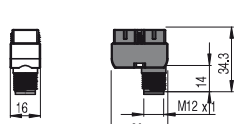
technopolymer connectors for NF housings	
M12 connector, right 	M12 connector, bottom 
VN CP11DMK 1NO+1NC	VN CP11SMK 1NO+1NC
VN CP02DMK 2NC	VN CP02SMK 2NC
VN CP22DMK 2NO+2NC	VN CP22SMK 2NO+2NC

technopolymer connectors for NA and NB housings	
AMP superseal 1.5 	
VN CM11SAK 1NO+1NC	
VN CM02SAK 2NC	
VN CM20SAK 2NO	

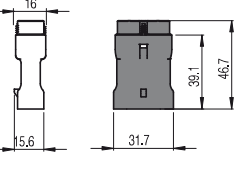
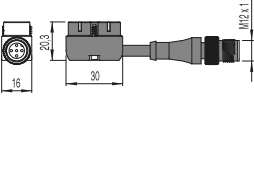
AMP superseal 1.5	
	with cable and M12 connector 
VN CP11SAK 1NO+1NC	VN CP11DM0.2 1NO+1NC
VN CP02SAK 2NC	VN CP02DM0.2 2NC
VN CP20SAK 2NO	VN CP22DM0.2 2NO+2NC

Items with code on green background are stock items

Accessories See page 197

The 2D and 3D files are available at www.pizzato.com



Actuators

All values in the drawings are in mm

 VN AA0AA	 VN AA0AB	 VN AA0AC	 VN AA0AE	 VN AA0BB	 VN AA0BE
 VN AA0CB	 VN AA0CH	 VN AA0CP	 VN AA0CV	 VN AA0EB	 VN AA0EE
 VN AA0FB	 VN AA0GB	 VN AA0HB	 VN AA0HE	 VN AA0HH	

Levers

All values in the drawings are in mm

ATTENTION: These separate actuators can be used only with items of the NA, NB and NF series.

 VN A00KA	 VN A00KB	 VN A00KC	 VN A00KD	 VN A00KE	 VN A00KF
 VN A00KG	 VN A00KH	 VN A00KP	 VN A00LB	 VN A00LE	 VN A00LH
 VN A00LL	 VN A00LP	Levers with external metallic parts in stainless steel			
 VN A00KB-V38	 VN A00KE-V38	 VN A00KG-V38	 VN A00KP-V38		

Heads

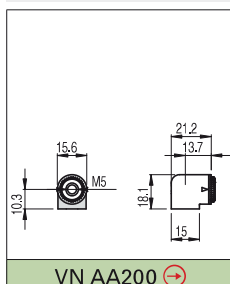

90° redirection

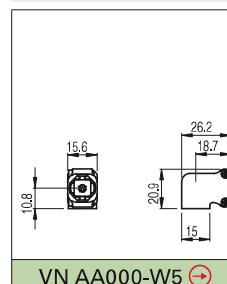

Items with code on green background are stock items

Accessories See page 197

The 2D and 3D files are available at www.pizzato.com