

# Cable-Extension Position Transducer

**0/4...20 mA Output**

**Ranges: 0-2 to 0-50 inches**

**Compact Size • OEM Applications**



# PT1MA

## Specification Summary:

### GENERAL

Full Stroke Range Options ..... 0-2 to 0-50 inches  
 Output Signal Options ..... 4...20 mA (2-wire) and 0...20 mA (3-wire)  
 Accuracy .....  $\pm 0.28\%$  to  $\pm 0.15\%$  full stroke *see ordering information*  
 Repeatability .....  $\pm 0.05\%$  full stroke  
 Resolution ..... essentially infinite  
 Measuring Cable ..... .019-in. dia. nylon-coated stainless steel  
 Enclosure Material ..... glass-filled polycarbonate and black anodized aluminum  
 Sensor ..... plastic-hybrid precision potentiometer  
 Potentiometer Cycle Life ..... *see ordering information*  
 Maximum Retraction Acceleration ..... *see ordering information*  
 Weight ..... 1 lb. max.

### ELECTRICAL

Input Voltage ..... *see ordering information*  
 Input Current ..... .20 mA max.  
 Maximum Loop Resistance (Load) ..... (loop supply voltage - 8)/0.020  
 Circuit Protection ..... .38 mA max.  
 Impedance ..... 100M ohms@100 VDC, min.  
 Output Signal Adjustment  
 Zero Adjustment ..... from factory set zero to 50% of full stroke range  
 Span Adjustment ..... to 50% of factory set span  
 Thermal Effects  
 Zero ..... 0.01% f.s./°F, max.  
 Span ..... 0.01% f.s./°F, max.

### ENVIRONMENTAL

Enclosure ..... NEMA 4, IP 65  
 Operating Temperature ..... 0° to 200°F (-17° to 90°C)  
 Vibration ..... up to 10 G's to 2000 Hz maximum

### EMC COMPLIANCE PER DIRECTIVE 89/336/EEC

Emission/Immunity ..... EN50081-2/EN50082-2



The PT1MA adds 4...20 mA position feedback signal to Celesco's compact line of cable-extension transducers. The PT1MA is available with full stroke ranges from as little as 2 inches on up to 50 inches with adjustable zero and span settings to precisely match the full scale output to your exact measurement range.

The PT1MA offers several options including forward and reverse 0...20 and 4...20 mA output signals, alternate measuring cable exits and a couple different electrical connection options.

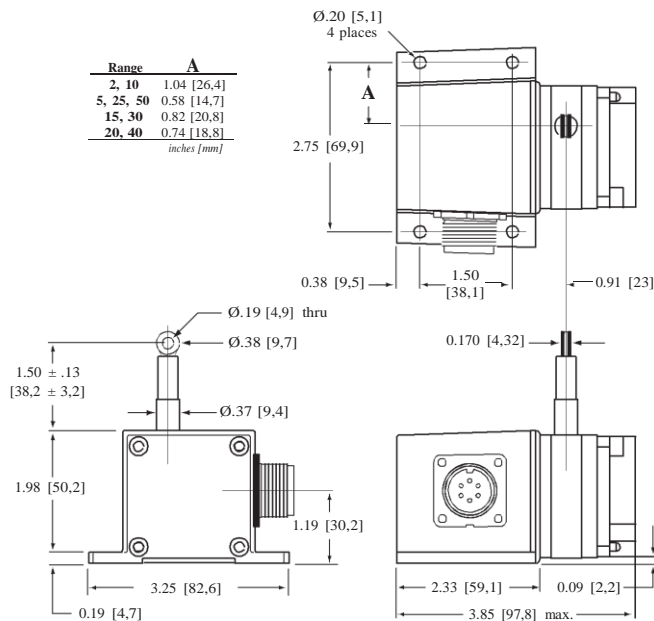

dimensions are in inches [mm], tolerances are 0.03 inches [0,8 mm]

### Output Signal

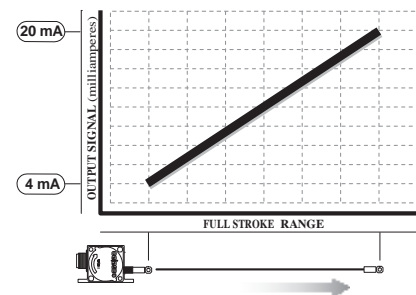

# PT1MA • Cable-Extension Transducer: 0/4...20 mA Output Signal

## Ordering Information:

### Model Number:

**PT1MA** - \_\_\_\_\_  
*order code:*    **R**    **A**    **B**    **C**    **D**

Sample Model Number:

**PT1MA - 30 - UP - 420E - MC4 - SG**

- R** range: 30 inches
- A** measuring cable exit: up
- B** output signal: 4...20mA
- C** electrical connection: 4-pin micro connector
- D** cable guide: spring-loaded guide

### Full Stroke Range:

<b>R</b> <i>order code:</i>	2	5	10	15	20	25	30	40	50
full stroke range, min:	2 in.	5 in.	10 in.	15 in.	20 in.	25 in.	30 in.	40 in.	50 in.
stroke accuracy (% of f.s.):	0.28%			0.18%			0.15%		
accumulator cycle life:	2,500,000 cycles			500,000 cycles			250,000 cycles		
potential									
cable tension (20%):	12 oz.	5 oz.	12 oz.	9 oz.	6 oz.	5 oz.	9 oz.	6 oz.	5 oz.
maximum cable acceleration:	11 G's	3 G's	11 G's	5 G's	4 G's	3 G's	5 G's	4 G's	3 G's

### Cable Exit:

**A** *order code:*    **UP**    **DN**    **FR**    **BK**  
 direction:        up        down        front        back

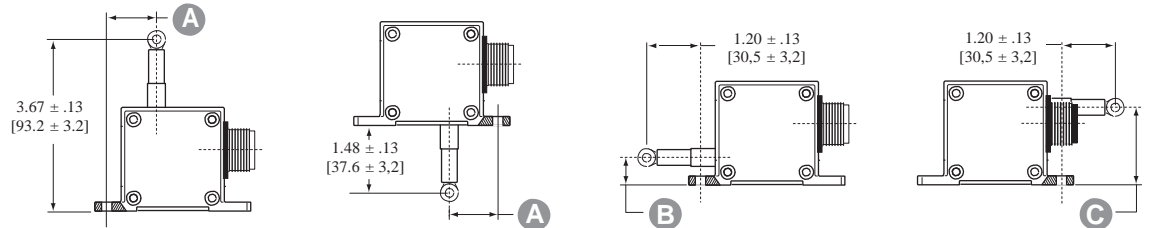

measurement range	2	5	10	15	20	25	30	40	50
<b>A</b>	1.04 in. 26.4 mm	0.58 in. 14.7 mm	1.04 in. 26.4 mm	0.82 in. 20.8 mm	0.74 in. 18.8 mm	0.58 in. 14.7 mm	0.82 in. 20.8 mm	0.74 in. 18.8 mm	0.58 in. 14.7 mm
<b>B</b>	0.75 in. 19.1 mm	0.29 in. 6.1 mm	0.75 in. 19.1 mm	0.53 in. 13.5 mm	0.45 in. 11.5 mm	0.29 in. 6.1 mm	0.53 in. 13.5 mm	0.45 in. 11.5 mm	0.29 in. 6.1 mm
<b>C</b>	1.43 in. 36.3 mm	1.89 in. 48.0 mm	1.43 in. 36.3 mm	1.65 in. 41.9 mm	1.73 in. 43.9 mm	1.89 in. 48.0 mm	1.65 in. 41.9 mm	1.73 in. 43.9 mm	1.89 in. 48.0 mm

### Output Signals:

<b>B</b> <i>order code:</i>	420E	420R	020E	020R
output signal options:	4...20 mA 	20...4 mA 	0...20 mA 	20...0 mA 
sensitivity:	16 mA/full stroke ±0.25%		20 mA/full stroke ±0.25%	
wiring configuration:	2 - wire		3 - wire	
input voltage:	8 - 40 vdc		14 - 29 vdc	

example:

ordercode = **420E** = 4...20 mA →  
 4 mA =   
 20 mA =

**Ordering Information (cont.)**

**Electrical Connection:**

① *order code:*

**MC4**  
4-pin micro-connector  
with 12 ft [3.5 M] cordset

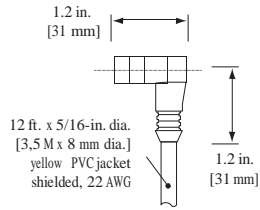

**M6**

6-pin plastic connector  
with mating plug

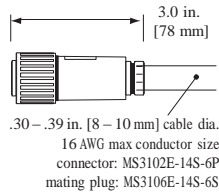

**C25**

25-ft. instrumentation cable  
24 AWG, shielded

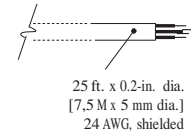

**4-pin mating plug and cordset:**

pin	color code	2-wire	3-wire
1	RED-BLK TR.	8...40 vdc	14...29 vdc
2	RED-WHT TR.	4...20 mA	common
3	RED	-	0...20 mA
4	GREEN	-	-



**6-pin mating plug:**

pin	2-wire	3-wire
A	8...40 vdc	14...29 vdc
B	4...20 mA	common
C	-	0...20 mA
D	-	-

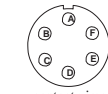

**25-ft. cable:**

color code	2-wire	3-wire
RED	8...40 vdc	14...29 vdc
BLACK	4...20 mA	common
WHITE	-	-
GREEN	-	0...20 mA

**Cable Guide:**

① *order code:*

**blank**

standard cable guide

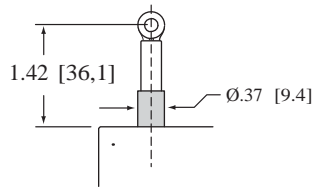

**SG**

spring-loaded guide

*cable-guide cushions impact from accidental free release*

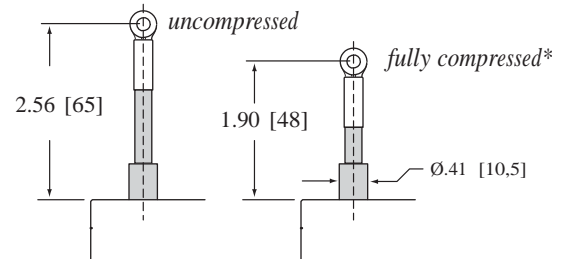

*\*note: start of full stroke range begins at full compression point (except 2-inch and 5-inch ranges).*

**Output Signal Selection:**

The output signal direction can be reversed at any time by

settings found on the internal signal board. After the settings have been changed, adjustment of the Zero and Span trimpots will be required to precisely match signal values to the beginning and end points of the stroke.

