

CONTINENTAL



HYDRAULICS™

CONTINENTAL HYDRAULICS

VSD05M

SOLENOID OPERATED DIRECTIONAL VALVES

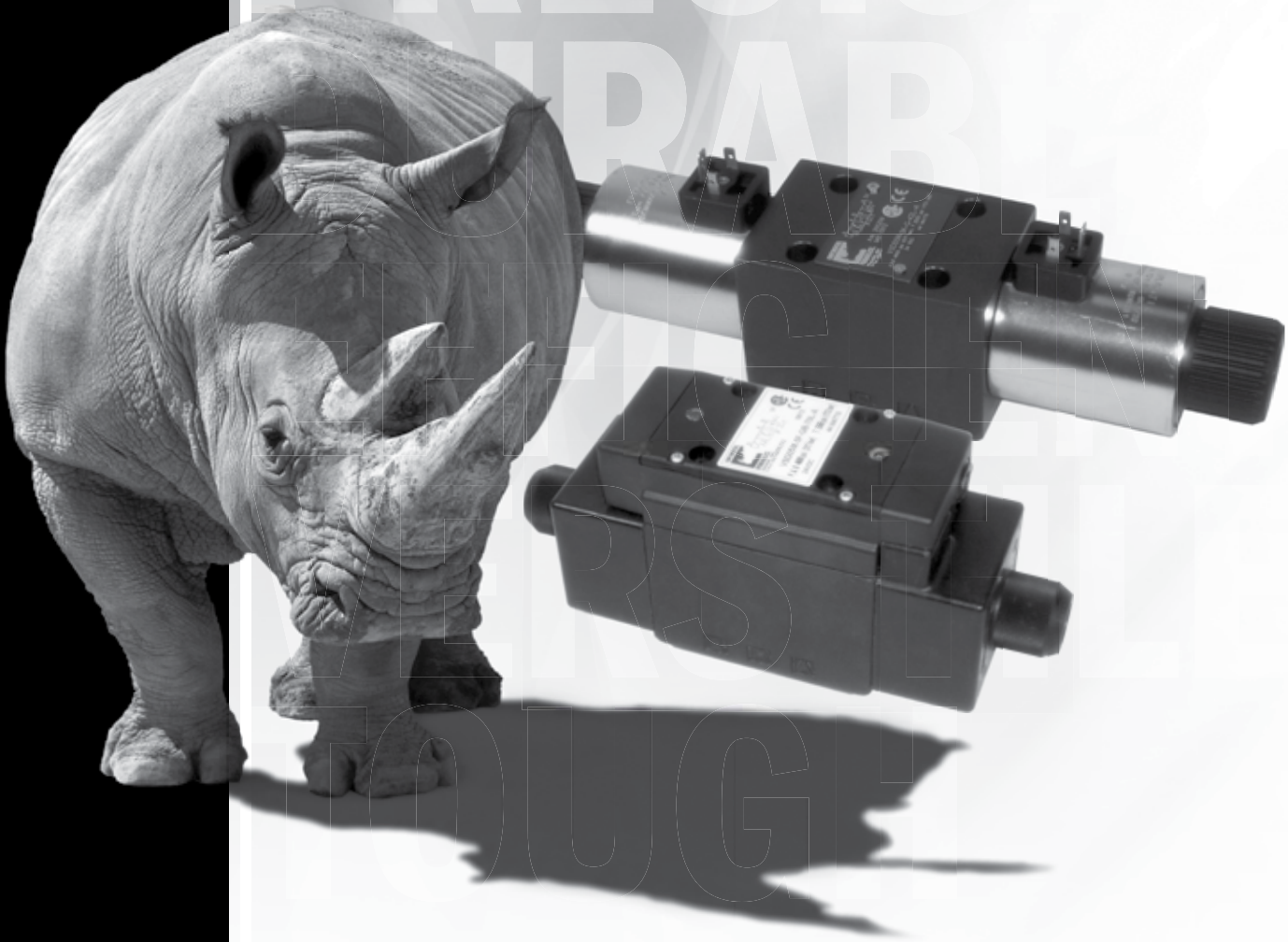

VSD05M - SOLENOID OPERATED DIRECTIONAL VALVES

VSD05M

SOLENOID OPERATED DIRECTIONAL VALVES

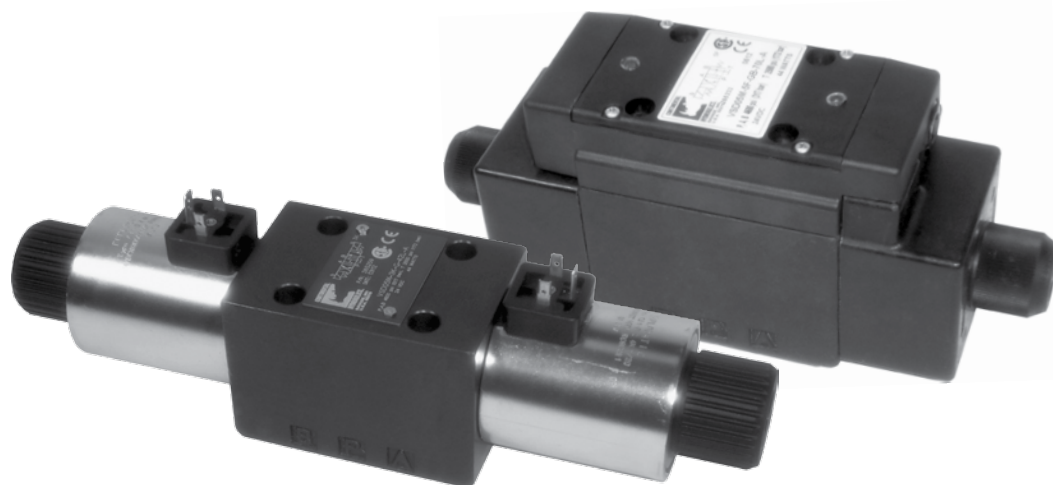

DESCRIPTION

These valves conform to NFPA D05 and ISO 4401 mounting standards. They are available in both 3 way and 4 way styles.

All versions are available in 2 position spring offset, 2 position detent, 2 position spring centered and 3 position spring centered versions.

A wide range of spools are available.

Standard and CSA approved versions are available.

TYPICAL PERFORMANCE SPECIFICATIONS

MAXIMUM OPERATING PRESSURE	P - A - B Ports	Standard		4600 psi	320 bar
		CSA		4000 psi	275 bar
	T Port	DC	STD	3000 psi	210 bar
			CSA	2500 psi	172 bar
		AC	ALL	2000 psi	140 bar
FLOW RATE	DC		38 gpm	145 lpm	
	AC		32 gpm	120 lpm	
MOUNTING SURFACE			NFPA D05, ISO 4401-05-04-0-05		
MAXIMUM WEIGHT	AC		8.0 lbs	3.6 kg	
	DC		10.6 lbs	4.8 kg	

RANGE TEMPERATURES	Ambient		-4 to +130°F	-20 to +54°C
	Fluid	Standard	-4 to +180°F	-20 to +82°C
		CSA	-4 to +150°F	-20 to +66°C
FLUID VISCOSITY	Range		60-1900 SUS	10-400 cSt
	Recommended		120 SUS	25 cSt
FLUID CONTAMINATION			ISO 4406:1999 Class 20/18/15	

IDENTIFICATION CODE

VSD05M - [] [] - [] [] [] [] - [] - [] **L** - [] _____ DESIGN LETTER

SOLENOIDS - See the codes on page 10

FUNCTION	
1	<p>Single Solenoid 2 Position Spring Offset</p>
	<p>Dual Solenoid 2 Position Detented (No Spring)</p>
3	<p>Dual Solenoid 3 Position Spring Centered</p>
	<p>Single Solenoid 2 Position Spring Centered</p>
6	<p>Single Solenoid 2 Position Energize To Center</p>
	<p>Single Operator 2 Position - 3 Way Spring Offset</p>

SEAL	
A	Buna (STD)
G	Viton

Spool Type
See Next Page

MECHANICAL OMIT IF NOT REQUIRED	
R	Single Solenoid Operator At 'B' Port End.
WD	Wash-Down

CONNECTION BOX OPTIONS OMIT IF NOT REQUIRED	
See the codes on page 9	

ELECTRICAL OPTION	
OMIT	Plug-in terminal solenoids or lead wires
B	Connection box with terminal posts and lights

APPROVALS	
OMIT	STD VALVE
CSA	CSA US/CAN

TYPICAL ORDERING CODE:
VSD05M-3A-AB5A-60L-B
VSD05M-3A-A-33L-B

VSD05M - SOLENOID OPERATED DIRECTIONAL VALVES

SPOOLS					
NAME	SYMBOL	FUNCTION	CENTER POSITION	CROSSOVER	FUNCTION MATCHING
A			All ports blocked	P→B or P→A T blocked	1, 2, 3, 5, 6
B			All ports open	All ports open	1, 2, 3, 5, 6
E			P and A blocked, and B→T	All ports blocked or P and A blocked and B→T	3, 5
F			P blocked, A→T and B→T	P blocked and A→T or B→T	3, 5, 6
F1			P blocked, A and B restricted to T	P blocked, A or B restricted to T	
G			P to A and B T blocked	P→B or P→A T blocked	
H			P and A to T, B blocked	All ports open, restricted	3, 5
K			P and B blocked, and A→T	P and B blocked and A→T or all ports blocked	
L			P→T, A and B blocked	All ports open, restricted	
Q			P and B to T, A blocked	All ports open, restricted	3, 5
X			-	All ports blocked	9

These are the standard configurations. Contact Continental Hydraulics for special versions.

PRESSURE DROPS ΔP -Q SHIFTED VALVE (OBTAINED WITH VISCOSITY OF 170 SUS - 36 CST AT 70°F - 21°C)

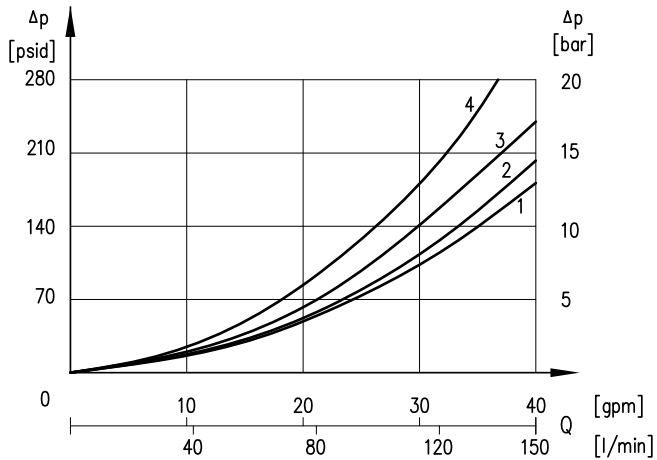

SPOOL	FLOW CURVE NUMBER			
	P→A	P→B	A→T	B→T
A	2	2	1	1
B	3	3	1	1
E, F, F1, K, 1A, 2A, 1B, 2B	3	3	2	2
H, L, Q	1	1	2	2
G	1	1	1	1

PRESSURE DROPS ΔP -Q CENTRAL POSITION

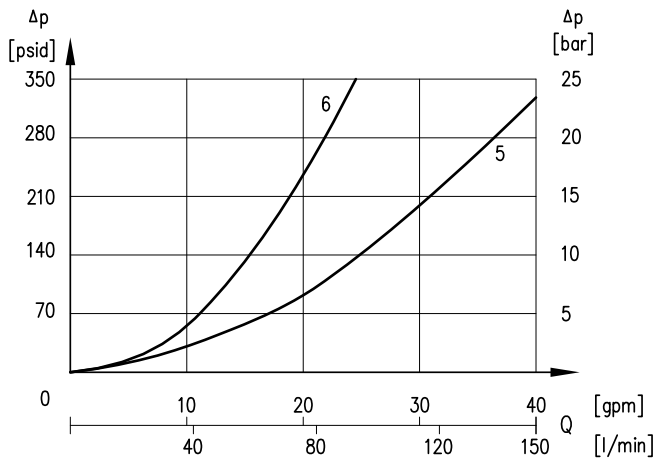

SPOOL	FLOW CURVE NUMBER				
	P→A	P→B	A→T	B→T	P→T
B, L, H, Q					5
E				6	
F			6	6	
G	3	3			
K			6		

PERFORMANCE CURVE

DC VOLTAGE

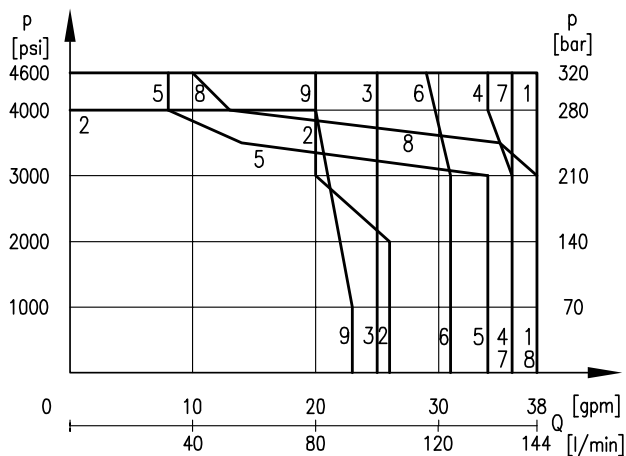

CURVE	SPOOL
1	A, B, G, 9X
2	L
3	1A
4	1A-R
5	F
6	1B
7	F1
8	E, K
9	H, Q

PERFORMANCE CURVE

AC VOLTAGE

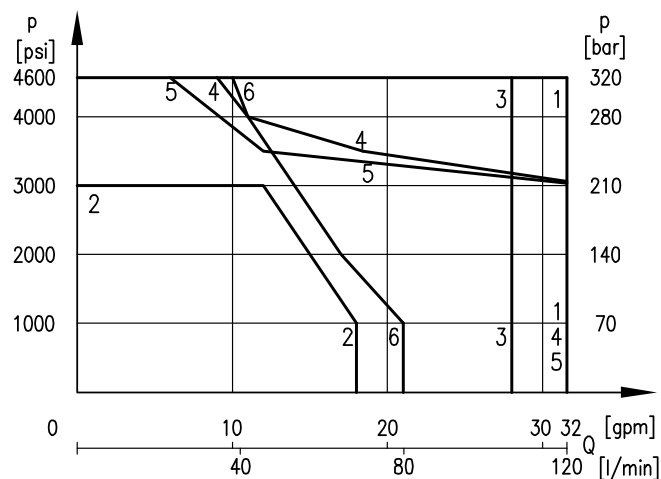

CURVE	SPOOL
1	A, B, G, 9X
2	L
3	1A
4	F, F1
5	K, E
6	H, Q

AC VOLTAGE - LOW FORCE

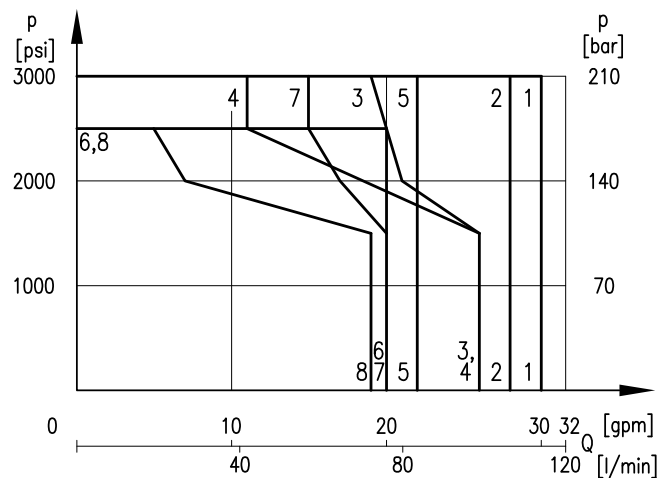

CURVE	SPOOL
1	1B, 2B, G
2	1B-R
3	1A
4	1A-R
5	B
6	A
7	2A
8	F

NOTES:

1. The values indicated in the graphs are relevant to the standard valve. The DC Performance Curve used a 42L coil, the AC Performance Curve used a 60L coil, and the AC Low Force Curve used a 68L coil.
2. Valve performance was tested in a four way circuit (full loop). Performances may be reduced from that shown when used in a three-way circuit (half circuit), i.e. A or B port plugged.
3. The values have been obtained according to ISO 6403 norm with solenoids at rated temperature and supplied with voltage equal to 90% of the nominal voltage. The value have been obtained with filtration according to ISO 4406:1999 class 18/16/13.

OVERALL AND MOUNTING DIMENSIONS - DIN STYLE VERSION

VSD05M-2*, 3*

Dimensions in mm [IN]

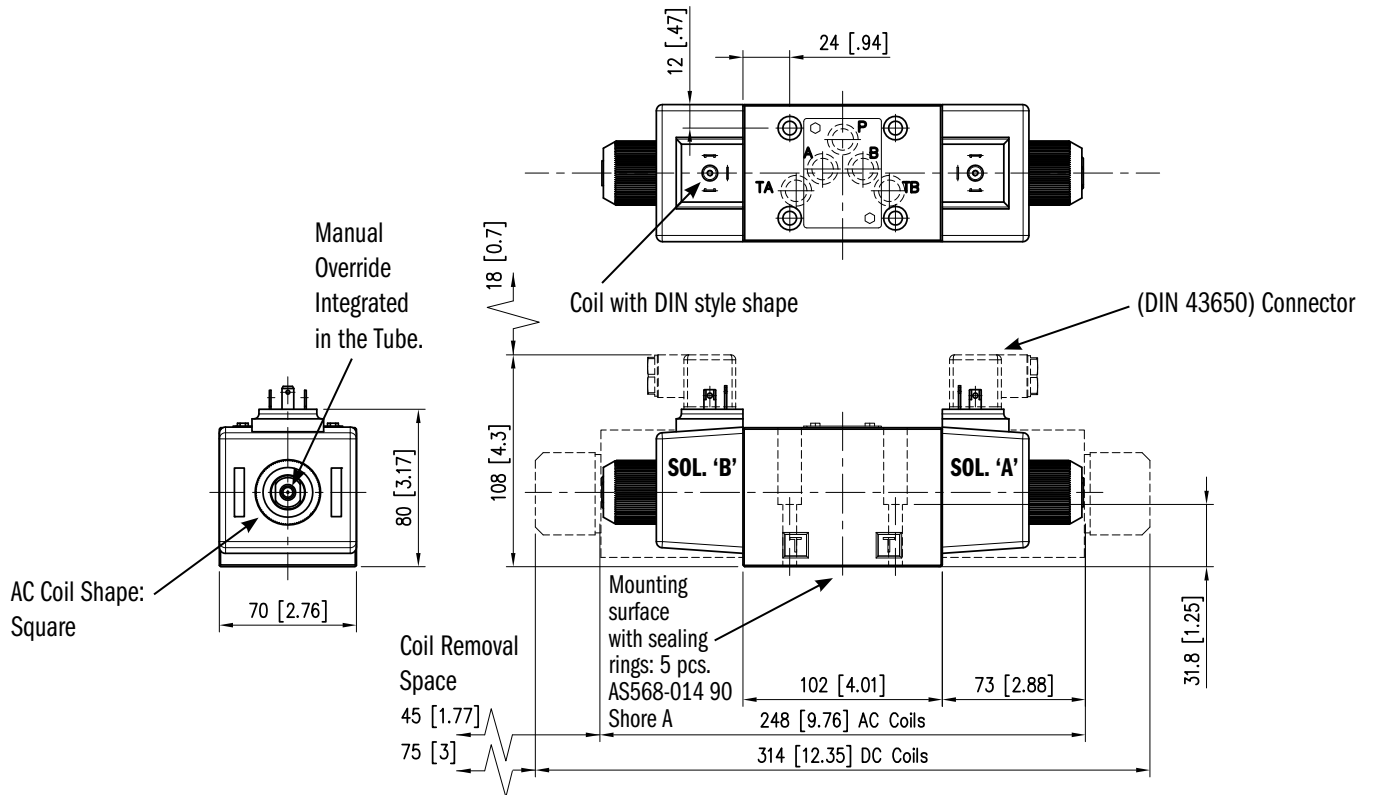

VSD05M-1*, 5*, 6*, 9*

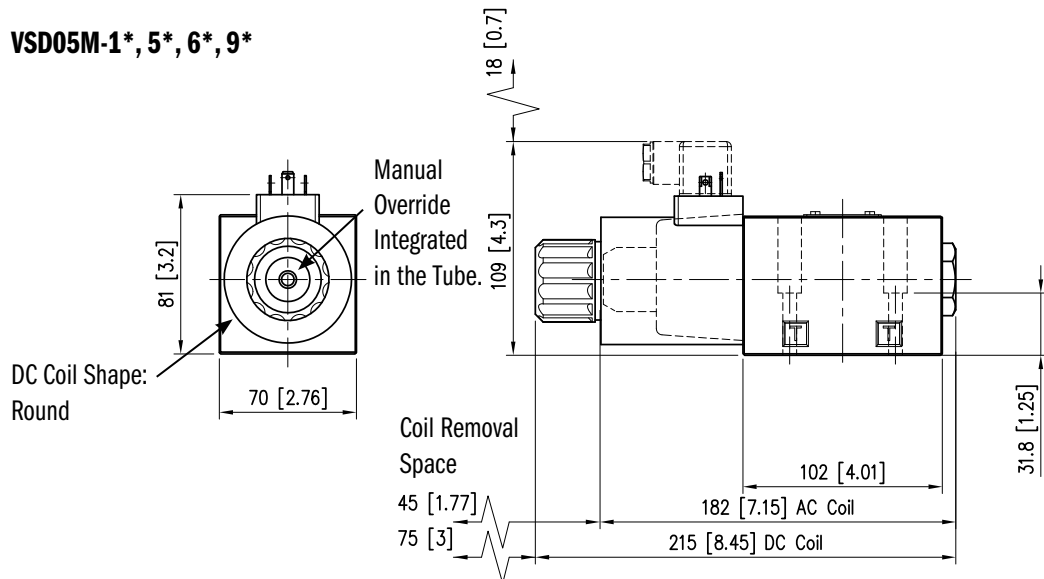

ELECTRICAL CHARACTERISTICS

Valves are available with an electrical connection box or with DIN 43650 solenoids in both AC and DC voltages. Deutsch DT04 or lead wires are also available in DC voltages only.

CONNECTION BOX OPTIONS

To simplify the connections and prevent wiring mistakes, we offer the option with connection boxes with quick connect pin receptacles, already wired.

Valves are available with receptacles on solenoid side 'A' or 'B' and several connector styles.

Below are the codes to be included in the box 'option' of the ordering code, depending on the version you choose.

Wiring diagrams below show the standard connections for 3-pin, 4-pin and 5-pin connectors. The commercially available mating "female" connector are not included.

CODE	PIN	SHAPE	PORT END	NOTES
5A	5	Male Mini	A	Single and Dual Solenoid
5H	5		B	
3A	3	Male Mini	A	Single Solenoid Only
3H	3		B	
4A	4	Male Micro	A	For DC Current Only. Different Wiring. See Schematics.
D4A	4		A	
4	4		B	
D4	4		B	

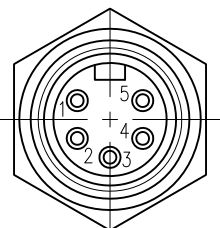

5 PIN RECEPTACLE

Male mini receptacles conform to NFPA/T3.5.29 R1 - 2007 used with single or double solenoid valve.

26 mm [1"] Wrench

1	Lead to Solenoid B
2	Lead to Solenoid A
3	Ground Lead (Green)
4	Lead to Solenoid A
5	Lead to Solenoid B

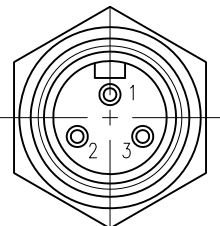

3 PIN RECEPTACLE

Male mini receptacles conform to NFPA/T3.5.29 R1 - 2007 used with single solenoid valve.

26 mm [1"] Wrench

1	Ground Lead (Green)
2	Lead to Solenoid
3	Lead to Solenoid

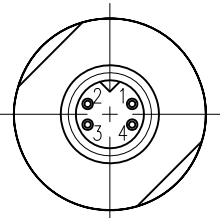

4 PIN RECEPTACLE

Male micro receptacles (M12x1 thread) used with DC valve only.

23 mm [7/8] Wrench

4A & 4		
1	Brown	Lead to Solenoid A
2	White	No Connection
3	Blue	Common Lead to Sol. A & B
4	Black	Lead to Solenoid B

D4A & D4		
1	Brown	No Connection
2	White	Lead to Solenoid A
3	Blue	Common Lead to Sol. A & B
4	Black	Lead to Solenoid B

SOLENOIDS

Listed below the types of solenoids available and the numbers to be added in the solenoid box on page 3.

PLUG-IN TERMINAL SOLENOID

DIN 43650

This solenoid has three terminal posts. Use bi-polar connectors that meet ISO 4400 / DIN 43650 (EN 175301-803). Protection against atmospheric agent: IP 65

CONNECTION BOX SOLENOIDS

This is a two pin solenoid which connects to the circuit board. Wiring is done on the terminal strip inside the box.

DIN CONNECTION CODE	BOX CONNECTION CODE	VOLTAGE & FREQ. [VOLT - HERTZ]	VOLTAGE LIMITS [MIN - MAX]	RESISTANCE $\pm 10\%$ [OHM]	INRUSH CURRENT [A]	HOLDING CURRENT [A]	HOLDING POWER [W]
33	60	120 - 60 110 - 50	108 - 126 99 - 116	9.2	5 6.2	0.91 1.1	45 43
34	61	240 - 60 220 - 50	216 - 252 198 - 231	38	2.9 3	0.48 0.53	45 43
NOT AVAILABLE	68	120 - 60 110 - 50	108 - 132 99 - 121	16.4	3.7 3.8	0.38 0.41	22 21
42	-	24 V DC	21 - 26	12	2	2	48
44	-	12 V DC	10 - 13	3.2	3.75	3.75	45
-	70	24 V DC	21 - 26	13.1	1.8	1.8	44
-	75	12 V DC	10 - 13	3.3	3.6	3.6	44

WASHDOWN OPTION (CODE WD)

The wash-down option with the electrical box is designed for an IP65 rating. This option uses a special cover without the mounting bolt access holes and uses silicone sealant to help seal between the coil and core tube.

The DIN, Deutsch and lead wire coils versions of the wash-down option uses silicone sealant to help seal between the coil and core tube.

APPLICATION DATA

FLUIDS

All pressure drops shown on these data pages are based on 170 SUS fluid viscosity and 0.87 specific gravity. For any other specific gravity (G1) the pressure drop (ΔP) will be approx. $\Delta P1 = \Delta P (G1/G)$. See the chart for other viscosities.

FLUID VISCOSITIES	Cst	10	14.5	32	36	43	54	65	76	86	108	216	324	400
	SUS	60	75	150	170	200	250	300	350	400	500	1000	1500	1900
MULTIPLIER		0.77	0.81	0.97	1.00	1.04	1.10	1.15	1.20	1.24	1.31	1.56	1.72	1.83

Use mineral oil-based hydraulic fluids HL or HM type, according to ISO 6743-4. For these fluids, use NBR seals. For fluids HFDR type (phosphate esters) use FPM seals (code G). For the use of other kinds of fluid such as HFA, HFB, HFC, please consult our technical department.

Using fluids at temperatures higher than 180 degrees F causes the accelerated degradation of seals as well as degradation of the fluids physical and chemical properties.

From a safety standpoint, temperatures above 130 degrees F are not recommended.

RANGE TEMPERATURES:	Ambient		-4 to +130 °F	-20 to +54 °C
	Fluid	STD	-4 to +180 °F	-20 to +82 °C
		CSA	-4 to +150 °F	-20 to +66 °C
FLUID VISCOSITY	Range		60 -1900 SUS	10 - 400 cSt
	Recommended		120 SUS	25 cSt
FLUID CONTAMINATION			ISO 4406:1999 Class 20/18/15	

INSTALLATION

Valves with centering and return springs can be mounted in any position without impairing correct operation. Valves with mechanical detent should have horizontal mounting.

Valves are fixed by means of screws or tie rods on a flat surface with planarity and roughness equal to or better than those indicated in the relative symbols. If minimum values are not observed, fluid can easily leak between the valve and support surface.

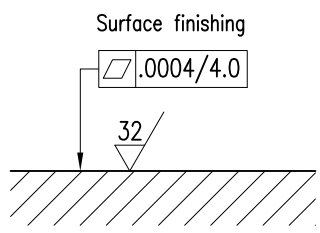

SEAL KIT

Buna Seal Kit	1015300
Viton Seal Kit	1015301

BOLT KIT

BD05-175	131110
----------	--------

POWERFUL
ACCURATE
INNOVATIVE
PRECISE
DURABLE
EFFICIENT
VERSATILE

ABOUT CONTINENTAL HYDRAULICS

Rugged, durable, high-performance, efficient—the reason Continental Hydraulics' products are used in some of the most challenging applications across the globe. With a commitment to quality customer support and innovative engineering, Continental's pumps, valves, power units, mobile and custom products deliver what the markets demand. Continental has been serving the food production, brick and block, wood products, automotive and machine tool industries since 1962. Learn how our products survive some of the most harsh environments.

CONTINENTAL



HYDRAULICS.