



Electronic High Performance Timing Relays

(Catalog Number 700–FS)

Product Data



The Bulletin 700–FS Electronic High Performance Timing Relays consist of Multi–Function, Single Function and Special Function designs. These products offer the customer optimum space utilization and maximum functionality. In addition, the timing ranges are easily adjusted, and the LEDs provide visual indication of the coil and timing status.

- 22.5mm (5/8 inch) Wide
- Dual Voltage
 - 24–48V DC
 - 24–240V AC
- DIN Rail Mounting
- Finger Safe Terminals
- Single Pull Double Throw (SPDT) Contact Configuration
 - Multi–Function/Multi–Range (On–Delay, Off–Delay, On–and–Off–Delay, One Shot, Fleeting Off–Delay, Flasher, On–Delay Pulse Generator, Pulse Converter, On–Function, Off–Function, with 10 Timing Ranges)
 - Single Function (On–Delay, Off–Delay, On–and–Off–Delay, One Shot, Fleeting Off–Delay, Flasher (Pulse), Flasher (Pause), On–Delay Pulse Generator, On–Delay (Pulse Controlled), One Shot/Watch Dog, Pulse Converter, with 12 Timing Ranges)
 - Special Function/Multi–Range (Flasher, True Off–Delay, Star–Delta, with 12 Timing Ranges)
- Double Pull Double Throw (DPDT) Contact Configuration
 - Multi–Function/Multi–Range (On–Delay, Off–Delay, On–and–Off–Delay, One Shot, Fleeting Off–Delay, Flasher, On–Delay Pulse Generator, Pulse Converter, On–Function, Off–Function, with 10 Timing Ranges)
 - Single Function/Multi–Range (On–Delay, Off–Delay, with 10 Timing Ranges)

Catalog Number Explanation

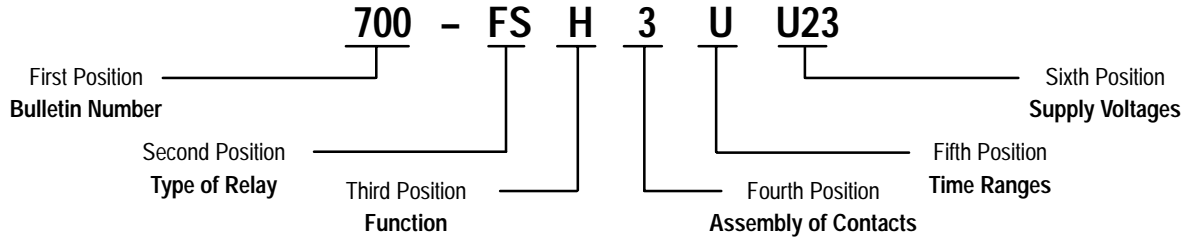

Multi-Function Timing Relays

700-FS	M	3	U	U23
	Function	Assembly of contacts	Time ranges	Supply voltages
	M Multi-function timing relays 8 Single-functions: A, B, C, D, E, F, I, & L. ON and OFF function additional (for installation and maintenance)	3 1 Change-over contact 1 C/O (SPDT) 4 2 Change-over contacts 2 C/O (DPDT)	U 0.05 s...60 h	Z12 12 VDC U23 24...48 VDC 24...240 V 50/60 Hz

Single Function Timing Relays



700-FS	A	3	A	U23
	Function	Assembly of contacts	Time ranges	Supply voltages
	A On-delay B Off-delay C On- and off-delay D One shot E Fleeting off-delay F Flasher (repeat cycle starts w/pulse) G Flasher (repeat cycle starts w/pause) I On-delay pulse generator J On-delay (pulse controlled) K One shot / watch dog (pulse controlled) L Pulse converter	all functions: 3 1 Change-over contact 1 C/O (SPDT) Functions A and B: 4 2 Change-over contacts 2 C/O (DPDT)	A 0.05...1 s B 0.15...3 s C 0.5...10 s D 1.5...30 s E 0.05...1 min F 0.15...3 min G 0.5...10 min H 1.5...30 min I 0.05...1 h J 0.15...3 h K 0.5...10 h L 3.0...60 h U 0.05 s...60 h	Z12 12 VDC U23 24...48 VDC 24...240 V 50/60 Hz NOTE: Only the 700-FSA and 700-FSB are available with the "U" multi-time setting ranges (0.05s to 60h).

Special Function Timing Relays

700-FS	H	3	U	U23
	Function	Assembly of contacts	Time ranges	Supply voltages
	H Flasher (repeat cycle starting with pulse or pause)	3 1 Change-over contact 1 C/O (SPDT)	U 0.05 s...60 h V 0.05 s ... 60 h (2 ranges)	Z12 12 VDC U23 24...48 VDC 24...240 V 50/60 Hz
700-FS	Q	3	Q	U18
	Function	Assembly of contacts	Time ranges	Supply voltages
	Q Off-delay without supply voltages (true off-delay)	3 1 Change-over contact 1 C/O (SPDT) 4 2 Change-over contact 2 C/O (DPDT)	Q 0.15 s ... 10 min	U18 24...240 VDC 24...240 V 50/60 Hz
700-FS	Y	2	C	U23
	Function	Assembly of contacts	Time ranges	Supply voltages
	Y Star-delta timing relays	2 2 normally open contacts 2 N.O.	C 0.5...10 s D 1.5...30 s E 0.05...1 min F 0.15...3 min G 0.5...10 min	U23 24...48 VDC 24...240 V 50/60 Hz

Technical Data

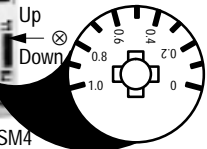

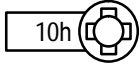
700-FSM Multi-Function High Performance Timing Relays

Description	SPDT		DPDT											
	Multi-time setting range 0.05 s...60 h													
 <p>Multi-function timing relays 700-FSM3U includes 10 setting functions:</p> <ul style="list-style-type: none"> (A) - On-delay (B) - Off-delay (C) - On- and off-delay (D) - One shot (E) - Fleeting off-delay (F) - Flasher (repeat cycle starts w/pulse) (I) - On-delay pulse generator (L) - Pulse converter (On) - ON-Function * (Off) - OFF-Function * <p>* (for installation and maintenance)</p>   														
<p>NOTE: Switch ⊗ is on DPDT relays only. When switch is down, one contact is instantaneous and one is timed. When switch is up, both contacts are timed.</p>	<p>Supply voltages (A1/A2)</p> <table border="1"> <tr> <td>U23</td> <td>24...48 VDC; 24...240 VAC, 50/60 Hz</td> </tr> <tr> <td>Z12</td> <td>12 VDC</td> </tr> </table>		U23	24...48 VDC; 24...240 VAC, 50/60 Hz	Z12	12 VDC	<table border="1"> <thead> <tr> <th>Cat. No.</th> <th>Cat. No.</th> </tr> </thead> <tbody> <tr> <td>700-FSM3UU23</td> <td>700-FSM4UU23</td> </tr> <tr> <td>700-FSM3UZ12</td> <td>700-FSM4UZ12</td> </tr> </tbody> </table>		Cat. No.	Cat. No.	700-FSM3UU23	700-FSM4UU23	700-FSM3UZ12	700-FSM4UZ12
U23	24...48 VDC; 24...240 VAC, 50/60 Hz													
Z12	12 VDC													
Cat. No.	Cat. No.													
700-FSM3UU23	700-FSM4UU23													
700-FSM3UZ12	700-FSM4UZ12													

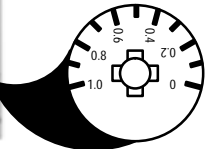
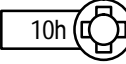
700-FS Single Function High Performance Timing Relays

Description	SPDT		DPDT																											
	available mono-time ranges		Multi-time setting ranges 0.05 s...60 h																											
 <p>22.5 mm Timing Relays</p>  <p>Supply voltages (A1/A2)</p> <table border="1"> <tr> <td>Z12</td> <td>12 VDC</td> </tr> <tr> <td>U23</td> <td>24...48 VDC</td> </tr> <tr> <td></td> <td>24...240 VAC, 50/60 Hz</td> </tr> </table>	Z12	12 VDC	U23	24...48 VDC		24...240 VAC, 50/60 Hz	<p>Complete the Cat. No. with the corresponding identification ⊙ from the table on the next page.</p> <p>NOTE: Only the 700-FSA and 700-FSB are available with the "U" multi-time setting ranges (0.05s to 60h).</p>		 <table border="1"> <tr> <td>(1s)</td> <td>0.05...1 s</td> </tr> <tr> <td>(3s)</td> <td>0.15...3 s</td> </tr> <tr> <td>(10s)</td> <td>0.5...10 s</td> </tr> <tr> <td>(1mn)</td> <td>0.05...1 min</td> </tr> <tr> <td>(3mn)</td> <td>0.15...3 min</td> </tr> <tr> <td>(10mn)</td> <td>0.5...10 min</td> </tr> <tr> <td>(1h)</td> <td>0.05...1 h</td> </tr> <tr> <td>(3h)</td> <td>0.15...3 h</td> </tr> <tr> <td>(10h)</td> <td>0.5...10 h</td> </tr> <tr> <td>(60h)</td> <td>3...60 h</td> </tr> </table>		(1s)	0.05...1 s	(3s)	0.15...3 s	(10s)	0.5...10 s	(1mn)	0.05...1 min	(3mn)	0.15...3 min	(10mn)	0.5...10 min	(1h)	0.05...1 h	(3h)	0.15...3 h	(10h)	0.5...10 h	(60h)	3...60 h
Z12	12 VDC																													
U23	24...48 VDC																													
	24...240 VAC, 50/60 Hz																													
(1s)	0.05...1 s																													
(3s)	0.15...3 s																													
(10s)	0.5...10 s																													
(1mn)	0.05...1 min																													
(3mn)	0.15...3 min																													
(10mn)	0.5...10 min																													
(1h)	0.05...1 h																													
(3h)	0.15...3 h																													
(10h)	0.5...10 h																													
(60h)	3...60 h																													
See 700-FS Timing Charts	Cat. No.		Cat. No.																											
<p>(A) On-delay The output contact changes state after the time delay is completed.</p>	700-FSA3CU23 700-FSA3FU23 700-FSA3UU23 700-FSA3⊙Z12 700-FSA3⊙U23		700-FSA4UU23 700-FSA4UZ12																											
<p>(B) Off-delay Input power must be supplied to terminal (A1/A2) continuously. The output contact changes state when switch "S" is closed. When switch "S" is opened, the time delay begins. After the time delay is completed, the contact returns to shelf state.</p>	700-FSB3CU23 700-FSB3FU23 700-FSB3UU23 700-FSB3⊙Z12 700-FSB3⊙U23		700-FSB4UU23 700-FSB4UZ12																											
<p>(C) On- and off-delay Input power must be supplied to terminal (A1/A2) continuously. The output contact changes state when switch "S" is closed and the time delay complete. When switch "S" is opened, the time delay begins again. After the time delay is completed, the contact returns to shelf state.</p>	700-FSC3KU23 700-FSC3LU23 700-FSC3⊙Z12 700-FSC3⊙U23		—																											
<p>(D) One shot The output contact changes state when the relay is energized. The output contact returns to shelf state when the time delay is completed.</p>	700-FSD3KU23 700-FSD3LU23 700-FSD3⊙Z12 700-FSD3⊙U23		—																											
<p>(E) Fleeting off-delay (Min. Pulse AC 50ms – DC 30ms) Input power must be supplied to terminal (A1/A2) continuously. The output contact changes state after closing and opening switch "S". After the time delay is completed, the contact returns to shelf state.</p>	700-FSE3KU23 700-FSE3LU23 700-FSE3⊙Z12 700-FSE3⊙U23		—																											
<p>(F) Flasher (Repeat Cycle Starting with Pulse) The output contact changes state when power is applied. At the end of the time delay, the output contact returns to shelf state. This cycle continues until the power is removed.</p>	700-FSF3KU23 700-FSF3LU23 700-FSF3⊙Z12 700-FSF3⊙U23		—																											

Technical Data, Continued

See 700-FS Timing Charts	 SPDT	 DPDT
	Cat. No.	Cat. No.
(G) Flasher (Repeat Cycle Starting with Pause) The output contact remains in the shelf state until the time delay is completed. When the time delay is completed, the contact changes state. This cycle continues until the power is removed.	700-FSG3KU23 700-FSG3LU23 700-FSG3⊙Z12 700-FSG3⊙U23	—
(I) On-delay pulse generator The output contact changes state when the time delay is completed. After 0.5s the contact opens.	700-FSI3KU23 700-FSI3LU23 700-FSI3⊙Z12 700-FSI3⊙U23	—
(J) On-delay (pulse controlled) (Min. Pulse AC 50ms – DC 30ms) Input power must be supplied to terminal (A1/A2) continuously. When switch "S" is closed, the time delay begins. The output contact changes state at the end of the time delay. The output contact returns to shelf state when the power to (A1/A2) is removed.	700-FSJ3KU23 700-FSJ3LU23 700-FSJ3⊙Z12 700-FSJ3⊙U23	—
(K) One shot / watch dog (pulse controlled) (Min. Pulse AC 50ms – DC 30ms) Input power must be supplied to terminal (A1/A2) continuously. When switch "S" is closed, the output contact changes state. The output contact will open when switch "S" is open for longer than the time setting.	700-FSK3KU23 700-FSK3LU23 700-FSK3⊙Z12 700-FSK3⊙U23	—
(L) Pulse converter (Min. Pulse AC 50ms – DC 30ms) Input power must be supplied to terminal (A1/A2) continuously. When switch "S" is closed, the output contact changes state. When the time delay is completed, the output contact returns to shelf state. The time "t" is not influenced by the duration of the control pulse.	700-FSL3KU23 700-FSL3LU23 700-FSL3⊙Z12 700-FSL3⊙U23	—

⊙ Mono-Time Ranges

Complete the Cat. No. with mono-time range identification

Time ranges	0.05...1 s	0.15...3 s	0.5...10 s	1.5...30 s	0.05...1 min	0.15...3 min	
⊙	A	B	C	D	E	F	
Time ranges	0.5...10 min	1.5...30 min	0.05...1 h	0.15...3 h	0.5...10 h	3.0...60 h	0.05 s...60 h
⊙	G	H	I	J	K	L	U

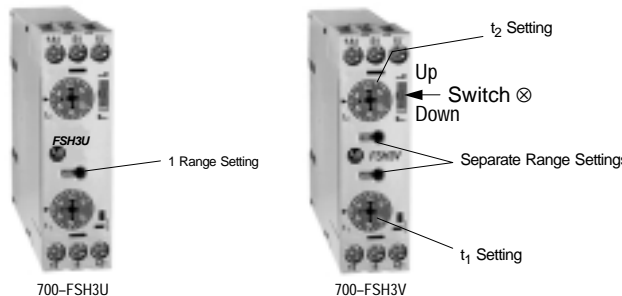
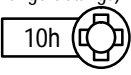

700-FSH Special Function Flasher (repeat cycle starting with pulse or pause) Timing Relays

Description		 SPDT
 <p>700-FSH3U (1 Range Setting)</p> <p>700-FSH3V (t₂ Setting, Up, Switch ⊙, Down, Separate Range Settings, t₁ Setting)</p>	<p>Supply voltages (A1/A2)</p> <p>Z12 12 VDC</p> <p>U23 24...48 VDC</p> <p>24...240 VAC, 50/60 Hz</p>	<p>Multi-time setting ranges</p> <p>U 0.05s...60 h (1 Range Setting)</p> <p>V 0.05s...60 h (2 Range Settings)</p> <p>(1s) 0.05...1 s</p> <p>(3s) 0.15...3 s</p> <p>(10s) 0.5...10 s</p> <p>(1mn) 0.05...1 min</p> <p>(3mn) 0.15...3 min</p> <p>(10mn) 0.5...10 min</p> <p>(1h) 0.05...1 h</p> <p>(3h) 0.15...3 h</p> <p>(10h) 0.5...10 h</p> <p>(60h) 3...60 h</p> <p></p>
See 700-FS Timing Charts		Cat. No.
<p>(H) Flasher (repeat cycle starting with pulse or pause)</p> <p>The repeat cycle timer permits different settings for on and off times. The following operating modes are possible:</p> <ul style="list-style-type: none"> – Oscillating mode; repeat cycle starts with voltage applied at A1 and B1, and continues to repeat until voltage is off. – One cycle mode; started by energizing B1 with voltage on A1 and A2. – Output starts with pulse or pause (switch ⊙ Up or Down). – 700-FSH3U provides (1) range setting for t₁ and t₂. – 700-FSH3V provides (2) range settings for t₁ and t₂. 		<p>700-FSH3UU23</p> <p>700-FSH3VU23</p> <p>700-FSH3UZ12</p> <p>700-FSH3VZ12</p>
Supply voltage controlled, Oscillating Mode starting with pause – Switch ⊙ is Up		
Supply voltage controlled, Oscillating Mode starting with pulse – Switch ⊙ is Down		
Pulse controlled, output starts with pulse (Min. Pulse AC 50ms – DC 30ms) – Switch ⊙ is Up		
Pulse controlled, output starts with pulse (Min. Pulse AC 50ms – DC 30ms) – Switch ⊙ is Down		



NOTE: If B1 is pulsed, a one full time cycle consisting of t₁ and t₂ is completed.

Technical Data, Continued

700-FSQ Special Function Off-Delay without Supply Voltage Timing Relays

Description	 SPDT	 DPDT
Supply voltages (A1/A2) U18 24...240 V AC 50/60 Hz 24...240 V DC	Multi-time setting range, Q 0.15 s...10 min (2.5s) 0.15...2.5 s (10s) 0.5...10 s (80s) 4...80 s (10mn) 0.5...10 min	
See 700-FS Timing Charts	Cat. No.	Cat. No.
(Q) Off-delay without supply voltage (true off-delay) When the input power is turned on, the output contact changes state. When the power is removed, the time delay begins. The output contact returns to shelf state at the end of the time delay.	700-FSQ3QU18	700-FSQ4QU18

700-FSY Special Function Star Delta Timing Relays

Description	 2 NO
 Supply voltages (A1/A2) U23 24...48 VDC 24...240 VAC, 50/60 Hz	Available mono-time ranges Complete the Cat. No. with the corresponding identification \odot from the table below.
	Cat. No.
(Y) Star-delta timing relay When power is applied, the output contact 17/18(Y) changes state. After the time setting, the output contact 17/18(Y) returns to shelf state. After the fixed time (50 to 60 ms), the output contact 17/28 Δ changes state. Both output contacts return to shelf state whenever the power is removed.	700-FSY2DU23 700-FSY2 \odot U23

\odot Mono-Time Ranges

Complete the Cat. No. with mono-time range identification. For 700-FSY relays only.

Time ranges	0.5...10 s	1.5...30 s	0.05...1 min	0.15...3 min	0.5...10 min
\odot	C	D	E	F	G

Specifications

Time characteristics (according to VDE 0435, Part 2021)

Setting accuracy	$\pm 5\%$ of full scale
Repeatability	$\pm 0.2\%$ of the setting values
Tolerance	voltage: $\pm 0.001\%/\Delta U$ temperature: $\pm 0.025\%/^{\circ}\text{C}$

Supply

Supply voltages	24...48 VDC and 24...240VAC, 50/60 Hz (dual voltage)
Voltage tolerance	-20% to +20% (DC), -15% to +10% (AC)
Power consumption	0.5 W at 24 VDC, 5 VA at 240 VAC
Time energized	100%
Reset time	50 ms
Voltage isolation	≤ 20 ms without reset (supply voltage)
Cable length - (supply voltage control)	max. 250 m (800 ft)

Pulse control (B1)

Pulse duration	≥ 50 ms (AC), ≥ 30 ms (DC)
Input voltage	Supply voltage range
Input current	1 mA
Cable length	max. 250 m (800 ft) without parallel load between B1 and A2 max. 50 m (160 ft) with load (< 3 k Ω) between B1 and A2

Specifications, Continued

Outputs

Contact type	Relay as changeover switch		
Switching capacity	Voltage: 440 VAC according to IEC 947-5-1: 3 A/440 VAC (inductive load, AC 14) 1 A/24 VDC (inductive load, DC 13) according to UL 508: 1.5 A/250 VAC (B300)	Current I_{th} : 8 A 3 A/250 VAC (inductive load, AC 15) 3 A/120 VAC (B300)	Power: 2000 VA
Short-circuit protection	10 A gL (Fast Blow Fuse)		
Life	mechanical: 30 Mil. of operations electrical operations: 4 Mil. at 1 A/250 VAC, $\cos \varphi = 1$ 1.5 Mil. at 1 A/250 VAC, $\cos \varphi = 0.3$ 0.5 Mil. at 6 A/24 VDC, resistive 2 Mil. at 0.2 A/230 VDC, resistive 1 Mil. at 0.2 A/110 VDC, L/R = 20 ms		
State indicator	1 LED, combination signal		
Setting accuracy	$\pm 5\%$ of full scale		

General Data

Insulation characteristics	2 kVAC/50 Hz test voltage according to VDE 0435 and 6 kV 1.2/50 μ s surge voltage according to IEC 947-1 between all inputs and outputs
EMC/Interference immunity	Performance of following requirements: Surge capacity of the supply voltage according to IEC 1000-4-5: 4 kV 1.2/50 μ s Burst according to IEC 1000-4-4: 6 kV 6/50 ns ESD discharge according to IEC 1000-4-2: Contact 8 kV, air 8 kV Electromagnetical HF field according to IEC 801-3 and conducted electromagnetical HF signal according to IEC 801-6: Level 3
EMC/Emission	Electromagnetical fields according to EN 55 022: class B
Safe isolation	according to VDE 106, part 101
Climatic withstand	56 Cycles (24 h) at 25...40°C and 95% rel. humidity according to IEC 68-2-30 and IEC 68-2-3
Vibration resistance	4 g in 3 axis at 10...500 Hz, test FC according to IEC 68-2-6
Shock resistance	50 g according to IEC 68-2-27
Protection class	Enclosure: IP 40 IP 30 (Single-function) Terminal: IP 20 according to IEC 947-1
Weight	100 g
Approval	UL, C-UL, Germanischer Lloyd, CE Certified
Ambient temperature	Open: -25°C ... +60°C Enclosed: -25°C ... +45°C Storage: -40°C ... +85°C
Terminals	Screw terminal M3.5 for Posidrive Number.2, Philips and slotted screws Number.2, suitable for power screwdriver. Rated tightening torque 8.8 LB-IN 0.8 Nm (max. 1.2 Nm) Dual-chamber system for terminal cross-sections of 1 x 0.5 mm ² ... 2 x 2.5 mm ² (solid) or stranded 2 x 2.5 mm ² (flexible with sleeve), AWG 20 to 14. Finger protection according to VDE 0106
Mounting	Front mounting; For snap-on mounting on DIN rail 35 mm or screw fixing by adapter and 2 screws M4
Disposal	Synthetic material without dioxin according to EC/EFTA notification Number. 93/0141/D – electrical contacts with cadmium

Approximate Dimensions

Dimensions are shown in millimeters (inches).
Dimensions are not intended to be used for
manufacturing purposes.

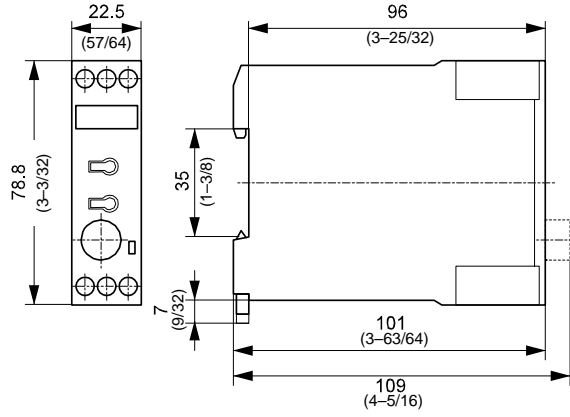

700-FS (1 C/O)

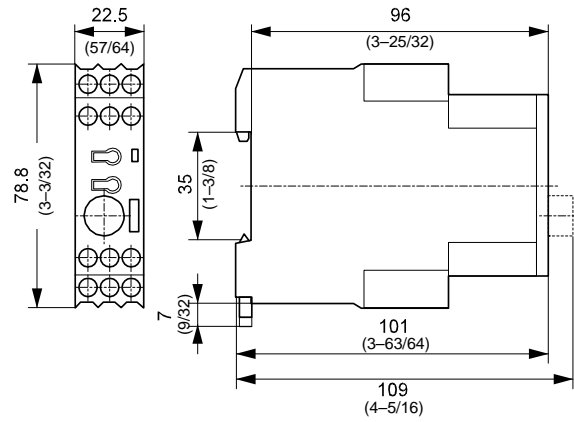

700-FS (2 C/O)

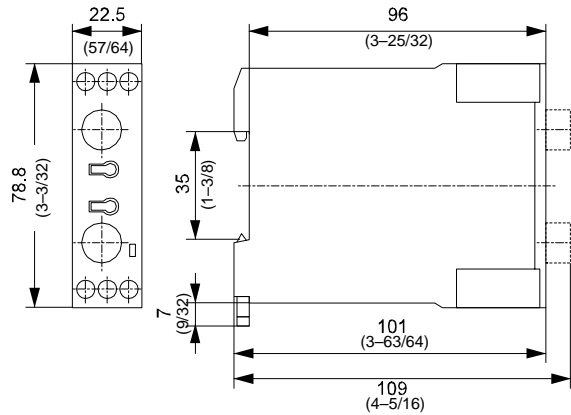

700-FSH3V...

For panel mounting, Use the 199-FSA Panel Mounting Adapter.

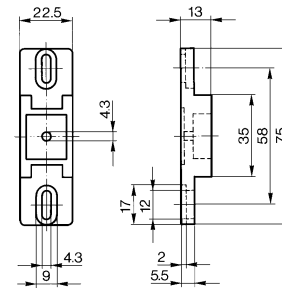

199-FSA

Timing Charts, Single Function

(A) On-delay

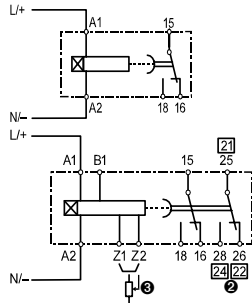
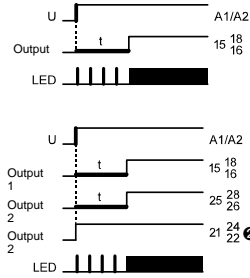

(B) Off-delay

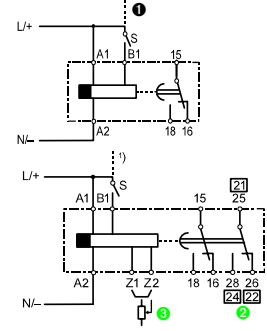
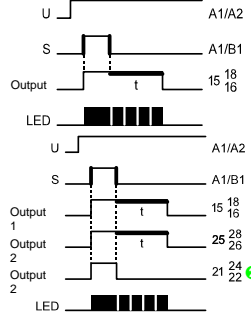

(C) On-and-Off-delay

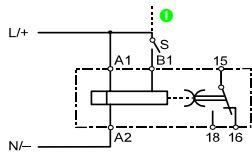
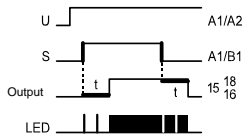

(D) One shot

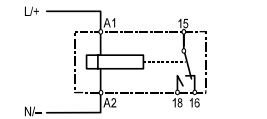
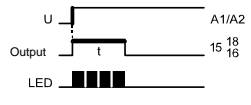

(E) Fleeting off-delay (Min. Pulse AC 50ms-DC 30ms)

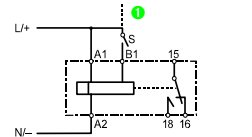
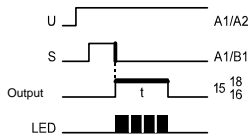

(F) Flasher (Repeat cycle starting with pulse)

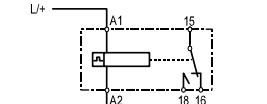
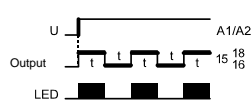

(G) Flasher (Repeat cycle starting with pause)

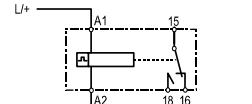
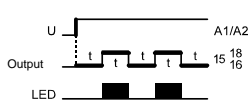

(I) On-delay pulse generator

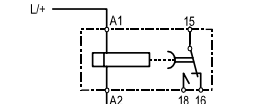
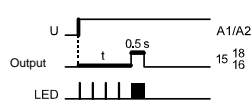

(J) On-delay (pulse controlled) (Min. Pulse AC 50ms-DC 30ms)

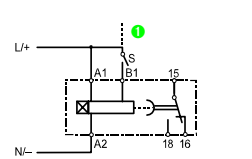
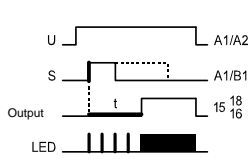

(K) One shot/watch dog (pulse controlled) (Min. Pulse AC 50ms - DC 30ms)

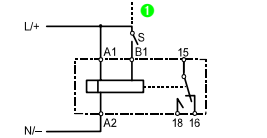
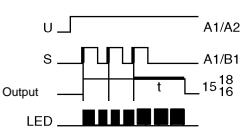

(L) Pulse converter

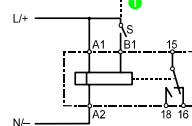
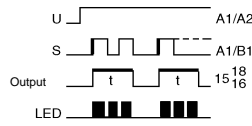

(On) ON-Function

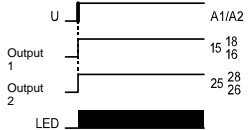

(Off) OFF-Function

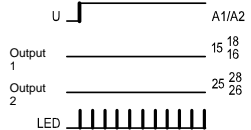

Cleverly designed function display LED (Green)

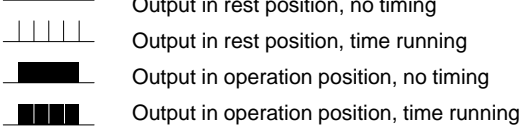

- ① A voltage other than the supply voltage can also be used at B1.
- ② Output 2, selectable as instantaneous contact with sliding switch (⊗) on front panel (instantaneous when switch is down, timed when switch is up).
- ③ Bridge or potentiometer 10 kΩ, min. 0.25 W (low voltage) for external time setting. Set timer dial to 0.0.

Timing Charts, Special Function

(H) Flasher repeat cycle timer – Switch “X” is Up

Supply voltage connected to A1 and B1.

Oscillating Mode starting with pause.

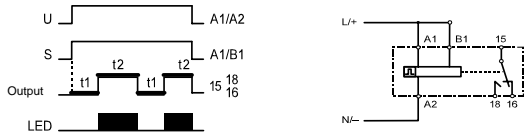

(H) Flasher repeat cycle timer – Switch “X” is Down

Supply voltage connected to A1 and B1.

Oscillating Mode starting with pulse.

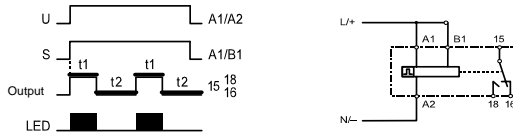

(H) Flasher repeat cycle timer – Switch “X” is Up

Pulse controlled, output starts with pause

(Min. Pulse AC 50ms – DC 30ms)

One Cycle Mode



(H) Flasher repeat cycle timer – Switch “X” is Down

Pulse controlled, output starts with pulse

(Min. Pulse AC 50ms – DC 30ms)

One Cycle Mode

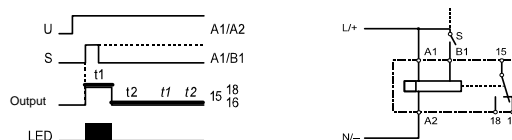

LED Operation Chart – Green LED

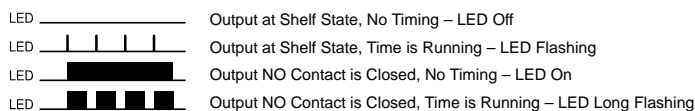

(Q) Off-delay without supply voltage (True Off-Delay)

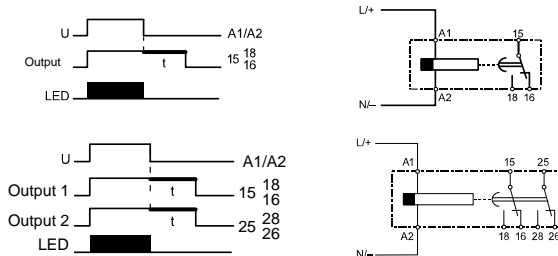

(Y) Star-Delta



Wiring Connections

- 17 Common
- 18 Y
- 28 Δ

2 NO with Common

Applications

Sequence	Description	Wiring Diagram
On-Delay (A) Switch (X) Down, (Contact 21-24/22) is Instantaneous 700-FSM DPDT Only Delayed Motor Starting	Pushing the Start Button energizes A1. After the time delay, Motor 1M will start	

Applications, Continued

Sequence	Description	Wiring Diagram
<p>Off-Delay (B) Switch (X) Down, (21-24/22) is Instantaneous 700-FSM DPDT Only Delayed Motor Stopping</p>	<p>A1 and A2 must be energized continuously. Pushing the Start Button will energize Motor 1M. Pushing the Stop Button will de-energize B1 and Motor 1M will be de-energized after the time delay is completed.</p>	
<p>On-and-Off Delay (C) Motor Starting and Stopping in a Sequence</p>	<p>Input Power must be applied to A1 and A2 continuously. Pushing the Start Button will energize B1 to start the On-Delay, and energize Motor 1M after the time delay is complete. When B1 is de-energized by pushing the Stop Button, the Off-Delay will begin, and Motor 2M will turn off after the time delay is completed.</p>	
<p>One Shot (D) Motor On for a Predetermined Time</p>	<p>Each time the Float Switch is closed, Motor 1M will run for the predetermined time that is set on the one shot timer.</p>	
<p>Fleeting Off-Delay (E) Motor On for a Predetermined Time After a Stop</p>	<p>Pushing the Start Button and then the Stop Button to energize and de-energize Motor 1M, will cause Motor 2M to be energized for a set time delay.</p>	
<p>Flasher (Repeat Cycle Starting with Pulse) (F)</p>	<p>When Limit Switch (1LS) closes, the Timer (TR) will close and open the contact, causing the forward FM and Reverse RM Motor Starters to go on and off.</p>	

Applications, Continued

Sequence	Description	Wiring Diagram
Flasher (Repeat Cycle Starting with Pause) (G) Turning On an Alarm Horn After a Time Delay	When Limit Switch (1LS) closes, the Timer TR will be energized. The Horn will not sound until the time setting is completed.	
On-Delay Pulse Generator (I) Turning On or Off a Latching Contactor for Lighting	The Selector Switch will energize the daylight sensor. The Contact (1DL) closes due to darkness and the Timer (1TR) will time out, and then close contact 1TR to send a pulse (0.5s) to the Latching Contactor to turn on the lights. When daylight comes, the switch 1DL will switch back and energize 2TR after a time delay. The 2TR contact will pulse closed (0.5s) to reset the lighting contactor. If the signals to 1DL are short, the 1TR and 2TR contacts will not pulse.	
On-Delay (Pulse Controlled) (J) Pulse Starts The On-Delay that Turns On a Motor	A1 and A2 must be energized continuously. A pulse or input from the "ON" Pressure Switch starts the On-Delay. After the delay is complete, the Motor 1M will start. A signal from the "Reset" Pressure Switch turns the Motor 1M off. The delay prevents short off times.	
One Shot/Watch Dog (Pulse Controlled) (K) Conveyor Keeps Running Only As Long As a Package is Sensed Every Time Setting (5 Min)	A1 and A2 must be energized continuously. A pulse must be received every time setting (or sooner) to maintain the Motor 1M running. This could be an energy saver, because the Motor 1M will turn off if the Photo SW is open for a period of time.	

Applications, Continued

Sequence	Description	Wiring Diagram
<p>Pulse Converter (L) Pulses Are Turned Into a Set or Predetermined Output</p>	<p>When the Photo Switch closes the first time, the contact TR closes to energize Motor 1M for the predetermined time setting. The timer will not be reset by the opening or pulsing of the Photo SW until the time delay is completed. Time setting is 0.05s to 10h.</p>	
<p>Off-Delay Without Supply Voltage (Q) (True Off-Delay)</p>	<p>A1 and A2 do not require continuous power for the off-delay time setting to be completed. Turning the switch to On will energize Motor 1M. When the switch is turned to Off, or the power is removed, Motor 1M will remain on for the time delay setting</p>	
<p>Star-Delta (Y) Starting a Star-Delta Motor</p>	<p>Pushing the Start Button energizes the relay CR and the timer TR. Both will hold in through CR. Contact 17-18 will close energizing the Star Contact (Y), and starting the motor for the predetermined time. Then contact 17-18 will open and 50ms to 65ms later contact 17-28 will close to energize the Delta Contact (Δ).</p>	



Allen-Bradley, a Rockwell Automation Business, has been helping its customers increase productivity and quality for more than 90 years. We design, manufacture and support a range of automation products worldwide. They include logic processors, power and motion devices, operator interfaces, sensors and a variety of software. Rockwell is one of the leading technology companies.

Worldwide representation.



Argentina • Australia • Austria • Bahrain • Belgium • Brazil • Bulgaria • Canada • Chile • China, PRC • Colombia • Costa Rica • Croatia • Cyprus • Czech Republic • De Ecuador • Egypt • El Salvador • Finland • France • Germany • Greece • Guatemala • Honduras • Hong Kong • Hungary • Iceland • India • Indonesia • Ireland • Israel • Jamaica • Japan • Jordan • Korea • Kuwait • Lebanon • Malaysia • Mexico • Netherlands • New Zealand • Norway • Pakistan • Peru • Philippines • Poland • Puerto Rico • Qatar • Romania • Russia-CIS • Saudi Arabia • Singapore • Slovakia • Slovenia • South Africa, Republic • Spain • Sweden • Switzerland • Taiwan • Turkey • United Arab Emirates • United Kingdom • United States • Uruguay • Venezuela • Yugoslavia

Allen-Bradley Headquarters, 1201 South Second Street, Milwaukee, WI 53204 USA, Tel: (1) 414 382-2000 Fax: (1) 414 382-4444

Publication 700-2.17 April 1998

Copyright 1998 Rockwell International Corporation Printed in USA