

behropur®

# Water Demineraliser

Pressure-resistant, Nylon



**behr**

Labor-Technik

User's Manual



Please read these operating instructions carefully before starting up your new behropur® water demineralisation unit!

The operating manual gives clear and simple instructions for use of the apparatus.

In the interest of eliminating risk please observe the safety instructions given in this manual! They are marked with a  symbol.

 Additional useful and important information on the functioning of the apparatus is mark with a bar at the left side of the text.

We wish you every success in your work with the

**behropur®  
water demineraliser  
pressure-resistant, Nylon**

## Safety advice



**Danger of electric shock! Make sure that no liquids get into the cable connections or the inside of the conductivity meter.**



**Caution: cartridge can topple and cause accident.  
Place the cartridge on a secure, flat place only.**

**Always shut the water supply** when leaving the demineralisation unit unattended for a longer time! In order to operate the device unattended, you need a behropur® leak protection set with leak sensor and a catchment tank.

When installing a new or regenerated cartridge, check the cartridge, the connections and tubing for damages.

Check for leaks on the cartridge and faulty connections after installation.

behropur® mixed-bed ion exchangers supply demineralised water according to the following specifications:

- Grade 3 as specified by ISO 3696:1987, Water for analytical use
- Pharma grade as specified by VDI 2083
- Pharmacopoea Europaea.

In special cases, for complete removal of fine particles an appropriate downstream filter might be needed, e.g. behropur® F 250 with an appropriate filter cartridge.

## Contents

1	Overview .....	6
2	Scope of Delivery .....	8
	Parts List .....	9
3	Installation .....	10
	Direct Connection of Conductivity meter .....	11
	Wall-Mounted Conductivity meter .....	12
	Conductivity meter – Built-In Version .....	13
4	Operation .....	15
	De-Aerating the Device .....	15
	Normal operation.....	16
	Flushing the Device.....	18
5	Replacement and regeneration.....	19
	What to do if.....	21
	Appendix .....	23
	Technical Data.....	23
6	Accessories.....	24
	Particle-Free Water .....	25
	Optimum Safety with behropur® Water Demineralisers .....	26

## 1 Overview

Setup of a complete water demineralization unit:

- 1.....Cartridge
- 2.....Supply tube with 3/4" connections at both ends
- 3.....Solenoid valve with connection cable
- 4.....3/4" adapter for supply tube, labelled
- 5.....Mains cable
- 6.....Limit switch jack
- 7.....Conductivity meter
- 8.....Level switch jack
- 9.....Measuring electrode
- 10.....3/4" adapter for outlet tube
- 11.....Outlet tube with 3/4" connection (one-sided)
- 12.....Float switch with cables (optional)

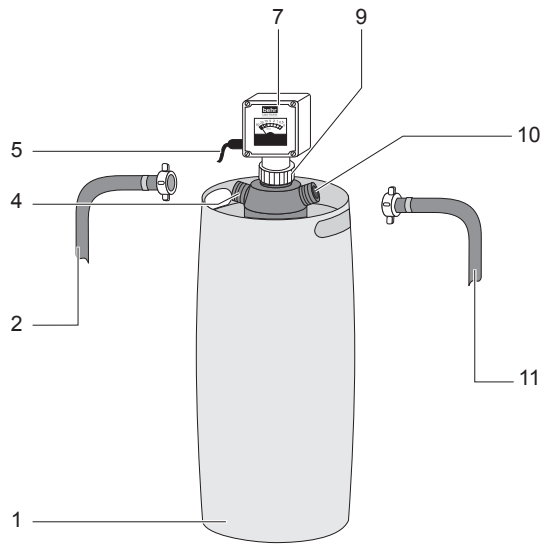

Without limit switch

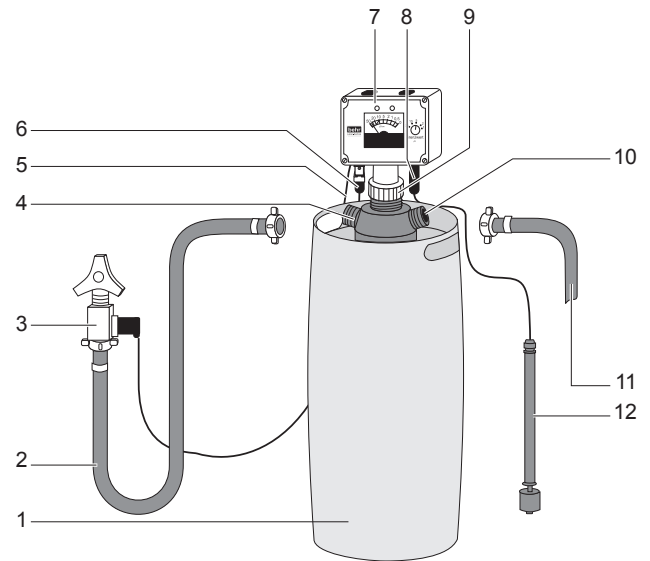

With limit switch

Fig. 1: Overview of a complete demineralization unit

## 2 Scope of Delivery

Immediately on receipt, check the contents of the delivery for absence of damage and completeness.

A claim for damage in transport, which is evident on the outside of the packing, must be immediately submitted to the carrier (postal, rail or road haulage carrier) – see the shipping label on the package.

If components are damaged, but no damage to the external packing was evident (concealed transport damage), contact the behr customer service immediately (also in the event of other complaints). The address is:

**behr Labor-Technik GmbH**

Spangerstraße 8  
D-40599 Düsseldorf

Phone: (+49 211) 7 48 47 17

Fax: (+49 211) 7 48 47 48

E-Mail: [info@behr-labor.com](mailto:info@behr-labor.com)

Please check the contents against the following list.



## Parts List

### Water demineralisation unit, complete without limit switch:

- Cartridge type B10dN, B22dN or B45dN, pressure-resistant up to 8 bar, Nylon, with ion exchanger resins
- Supply tube with coupling nuts and 3/4" connection thread (both ends)
- Outlet tube with coupling nut and 3/4" connection thread (one-sided)
- Conductivity meter type LFD

### Water demineralisation unit, complete with limit switch:

- Cartridge type B10dN, B22dN or B45dN, pressure-resistant up to 8 bar, Nylon, with ion exchanger resins
- Supply hose with coupling nuts and 3/4" connection thread (both ends)
- Outlet tube with coupling nut and 3/4" connection thread (one-sided)
- Conductivity meter type GLD with limit switch
- Solenoid valve with strainer and connection cable

### optionally if ordered separately:

- Float switch with cable for level control
- behropur® leak protection set with leak sensor and a catchment tank.

### 3 Installation

#### Assembly and connection to water supply

When installing the device please observe the local plumbing regulations and water board instructions!



**Caution: cartridge can topple and cause accident. Place the cartridge on a secure, flat place only.**

Keep the device protected from frost and from excessive temperature. The optimum operating temperature is 5 °C bis 20 °C.



**Caution: tightening the plastic caps by force will damage the threading! Tighten the plastic cap nuts by hand only, never use pliers.**

If, later on, the cartridge won't get tight by screwing the connections on by hand, there are probably particles in the threading (e.g. resin particles). Clean the threading, and it will hold tight again.

Protect the unit from freezing and from excessive heat. The optimum temperature is 5 to 20 °C.

- ▶ Remove the cartridge from its packaging.
- ▶ Unscrew the plugs.

Keep the carton and plugs for when you want to send in the cartridge for regeneration.

**Always shut the water supply** when leaving the demineralisation unit unattended for a longer time! In order to operate the device unattended, you need a behropur® leak protection set with leak sensor and a catchment tank.

When installing a new or regenerated cartridge, check the cartridge, the connections and tubing for damages.

Check for leaks on the cartridge and faulty connections after installation.

- ▶ Connect to water mains.

*Devices without limit switch:* Connect the inlet hose (2, Fig. 1) to a water tap with 3/4" threading.

*Devices with limit switch:* Connect the solenoid valve (3, Fig. 1) to a water tap with 3/4" threading.

- ▶ Set up the cartridge on its place.

## Direct Connection of Conductivity meter

Screw the conductivity meter with built-in measuring electrode (Fig. 2) on the middle nozzle of the cartridge by hand.

*When using a conductivity meter with limit switch:*

- ▶ Connect the cable of the solenoid valve (3, Fig. 1) to the limit switch jack (6, Fig. 1).

*Optionally:*

- ▶ Connect the cable of the level switch (12, Fig. 1) to the level switch jack (8, Fig. 1).

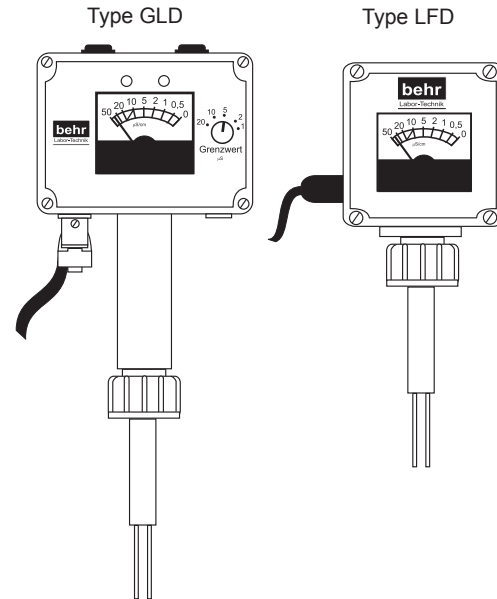

Fig. 2: Conductivity meters with built-in measuring electrode

## Wall-Mounted Conductivity meter

- ▶ Fasten the wall mounting brackets with two M3x2 countersunk screws each to the back of the conductivity meter (Fig. 3).
- ▶ Hold the conductivity meter and brackets against the wall and mark the positions of the fixing holes.
- ▶ Insert rawl plugs and the screws supplied so that the bracket can be suspended from the screws.
- ▶ Hang the conductivity meter and brackets on the screws.
- ▶ Screw the measuring electrode (Fig. 4) on the adapter in the middle of the cartridge by hand.
- ▶ Plug the measuring electrode cable into the appropriate socket (Fig. 3) on the conductivity meter.

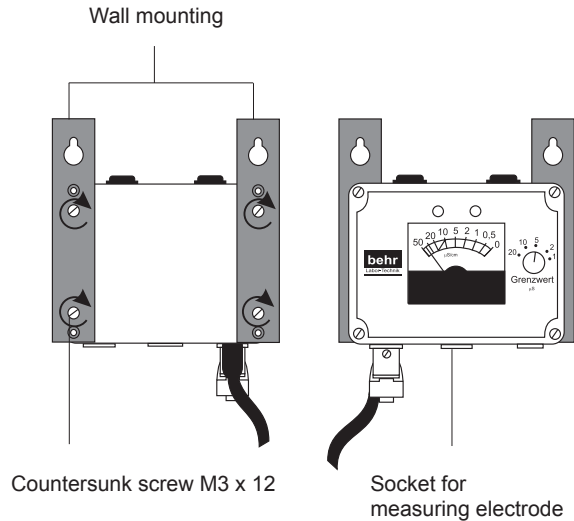

Fig. 3: Wall-mounted conductivitymeter

*When using a conductivity meter with limit switch:*

Connect the cable from the solenoid valve (No. 3, Fig. 1) to the limit switch jack (No. 6, Fig. 1).

Optional:

Connect the cable from the float switch (No. 12, Fig. 1) to the level switch jack (No. 8, Fig. 1).

### **Conductivity meter – Built-In Version**

1. Screw the measuring electrode (Fig. 4) on the adapter in the middle of the cartridge by hand.
2. Insert the conductivity meter into the switch-board.

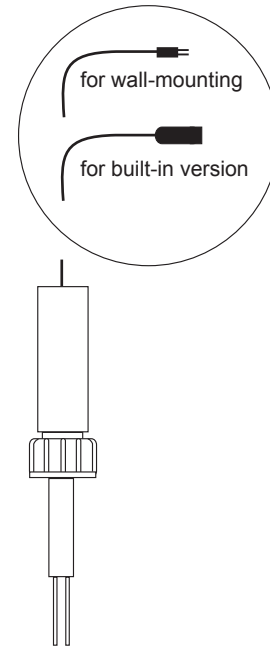
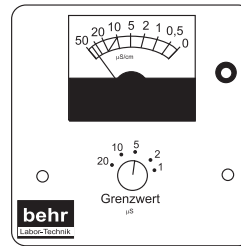

Fig 4: Measuring electrode

## Water demineraliser, pressure-resistant, Nylon

- Slide on the bracket included in the delivery (Fig. 5) and screw on the conductivity meter.
- Connect the cables from the rear of the conductivity meter (Fig. 5) like this:
  - ..... Mains
  - ..... Solenoid valve (conductivitymeters with limit switch only)
  - ..... Measuring electrode

Use cables with 2.5 mm<sup>2</sup> maximum wire gauge only.



Built-in mounting with screws

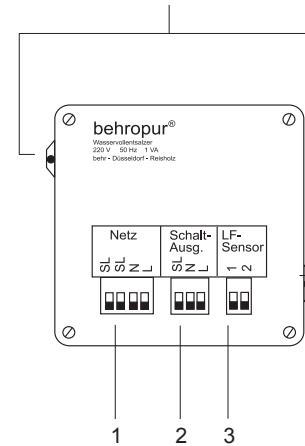

Fig 5: Built-in version of a conductivity meter with limit switch

## 4 Operation

### De-Aerating the Device

For the capacity of your behropur® cartridge to be fully usable, there must be no air left in the cartridge. De-aerate the cartridge whenever you have taken a new or regenerated cartridge into service and whenever you had to disconnect and reconnect the supply and outlet tubes. For de-aeration, swap the supply and the outlet tubes.

Do the de-aeration like this (Fig. 6):

1. Connect the inlet hose to the *Outlet nozzle*.
2. Open the water tap until water comes out at the *inlet nozzle*.
3. Now close the water tap and disconnect the inlet hose from the water tap.

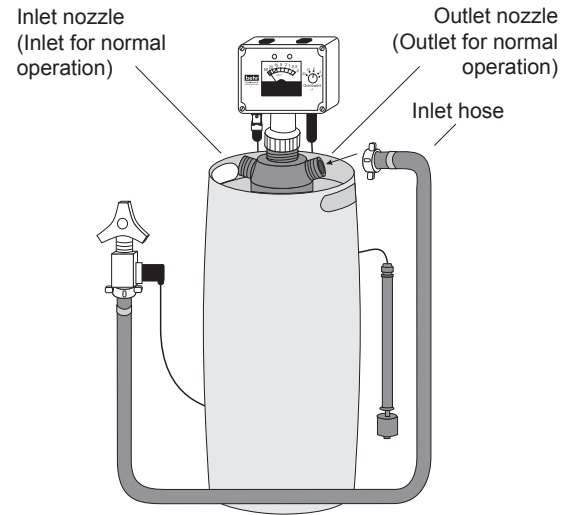

Fig. 6: De-aerating the device

## Normal operation



Danger of electric shock! Make sure that no liquids get into the cable connections or the inside of the conductivity meter.

Protect the cartridge against freeze so the resins will not freeze.

Before longer times of standstill always shut off the water supply to the demineraliser.

Do not disconnect the inlet hose each time after drawing water. Intrusion of air would deminish the capacity of your behropur<sup>®</sup> cartridge.

Make sure a new cartridge is ready when needed.

The quality of the water drawn will be optimal as long as the pointer of the conductivity meter stays in the green range of the graduation. Capacity is exhausted when the pointer moves into the red range.

Take the device into service like this:

1. Connect the supply tube (2, Fig. 1) to the supply tube adapter (4, Fig 1).
2. Connect the outlet tube (11, Fig. 1) to the outlet tube adapter (10, Fig. 1) and run it to the supply tank.
3. Connect the conductivity meter to a 220 V/50 Hz AC socket outlet.
4. Open the tap slightly. The cartridge will fill with water.

If the outlet is closed the cartridge cannot fill with water.



*When using a conductivity meter without limit switch:*

5. Draw deionised water.

After reaching the 10  $\mu\text{S}$  mark, it won't be possible anyhow to draw much more deionised water.

*When using a conductivity meter with limit switch:*

6. Use the turnknob to set the limit as desired (Fig. 7).  
The solenoid valve will shut off the water supply as soon as conductivity has reached this value. The switch limit is preset as 5  $\mu\text{S}/\text{cm}$ ; it can be changed as needed.
7. Switch the device on by switching the rocker switch on the upside of the conductivity meter (Fig. 7) into "I" position (not for built-in versions).
7. Draw deionised water.

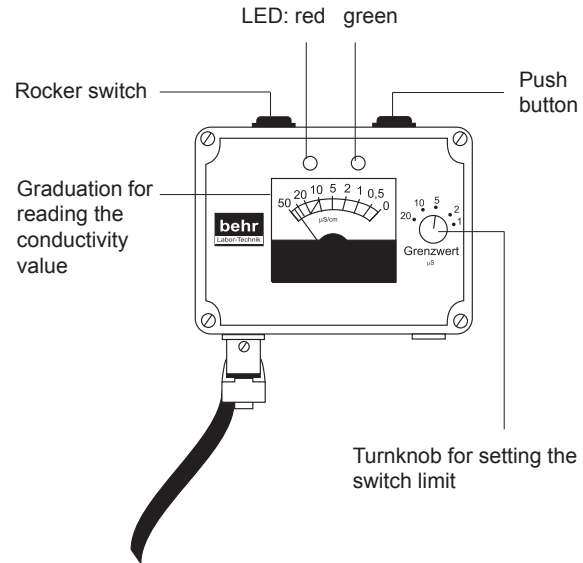

Fig. 7: Conductivity meter with limit switch

## Water demineraliser, pressure-resistant, Nylon

The LED indicators (Fig. 7) show the operating status of the water demineralisation unit:

Green:..... solenoid valve open,  
water intake open

Red:..... solenoid valve closed,  
water intake shut off

If a float switch is being used the solenoid valve will shut off the water supply as soon as the water in the supply tank has reached the switching level.

### Flushing the Device

After a longer time of standstill (e. g. vacancies), the dial may be in the red range even though the capacity of the resins is not yet exhausted.

In this case flush the device until the dial returns into the green range.

With devices with limit switch, press the black pushbutton (Fig. 7) on the upside of the conductivity meter or, with built-in versions, the green button on the front side. As long as you keep this button pressed, the automatic switch-off is shunted out so water can pass through.

You can also use this button to fill a storage tank.

## Replacement and regeneration

When installing a new or regenerated cartridge, check the cartridge, the connections and tubing for damages.

Check for leaks on the cartridge and faulty connections after installation.

When the conductivity limit is reached the capacity of the ion exchanger resin is exhausted. The cartridge must be regenerated and replaced by a spare.

Set the conductivity limit depending on your demands:

- **5  $\mu\text{S}$**  for pharmaceutical use
- **10  $\mu\text{S}$**  for battery water (VDE)
- **20  $\mu\text{S}$**  for various purposes

When a limit of 20  $\mu\text{S}/\text{cm}$  is reached, the exchange capacity of the resins is exhausted in any case.

When changing the cartridge the following sequence must be observed:

- ▶ Close the inlet tap.
- ▶ Release the tube connections.

Caution: There will still be water in the hoses!

- ▶ Unscrew the measuring electrode or the conductivity meter complete with measuring electrode.
- ▶ Let the cartridge drip dry.
- ▶ Close the inlet and outlet pipes with plugs.
- ▶ Replace the original cartridge with a spare cartridge.

- ▶ Send the cartridge containing the exhausted resins to the behropur® regeneration service or another authorised regeneration centre in the special carton provided:

**behr Labor-Technik GmbH**

Spangerstraße 8

D – 40599 Düsseldorf/Germany

behropur® cartridges regenerated in any other way are not covered by the manufacturer's guarantee!

Protect the cartridge against freezing during transport.

## What to do if...

<b>Malfunction</b>	<b>Possible cause</b>	<b>Remedies</b>
Water dripping out of threaded joints	Gasket rings are missing or worn	Check or replace the gaskets
Poor exchange quality / conductivity is not achieved	Changed composition of mains water due to a water softening plant or phosphate trap	Directly connect the device to mains water
	Burst pipe or pipe repair	Flush
	Effect of heat from warm or hot water	Connect the system to a cold water tap only
	Resin frozen	Allow the resins to thaw for several days. The system must always be protected against freezing.
	Cartridge defective	Send in the cartridge to the factory.

## Water demineraliser, pressure-resistant, Nylon

<b>Malfunction</b>	<b>Possible cause</b>	<b>Remedies</b>
Poor exchange quality / conductivity is not achieved (continued)	Demineralised water drawn off in very small quantities at long intervals	Use a supply tank with a capacity of at least 10 L.
	Demineralised water drawn off by several users within a short time	Check how much water is really being drawn (use a supply tank)
	Conductivity meter defective; damage in transit	Check functions. Send appliance in for service.
	Supply and outlet tubes connected up wrongly	Reconnect tubes as described in the Installation chapter.
	Power supply interrupted	Re-establish power supply.
	System unused for long periods (e.g. vacation)	Run through a few litres of water until the pointer moves to the green range.

If you cannot remedy the faulty functioning of your system you should always contact our customer service:

**behr Labor-Technik GmbH** • Spangerstraße 8 • 40599 Düsseldorf

phone: +49 – 211 – 7 48 47 33 • fax: +49 – 211 – 7 48 47 48 • E-Mail: [service@behr-labor.com](mailto:service@behr-labor.com)

## Appendix

### Technical Data

Nominal voltage	230 V AC, 50 Hz
Water pressure	min. 1.5 bar – 8 bar gauge pressure
Surrounding temperature	5 °C to 20 °C

## Accessories



FG 130 plus AF 130



FG 130



AF 130

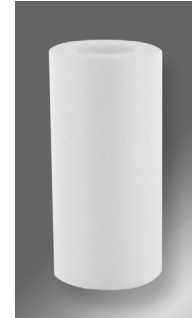

FE 130



## Particle-Free Water

You need water free of particles? A behropur® Filter FG 130 with a suitable filter insert will guarantee that. Connected downstream the ion exchanger, it will keep even the tiniest particles back completely, thus protecting your valuable equipment. With the transparent housing of the FG 130 you can at any time keep trace of the state of the filter insert with one glance.

Depending on your demands, you can employ a Universal Filter (5µ) or an active-charcoal filter insert (20µ).

**Downstream filters may only be operated with pressure-resisant behropur® ion exchangers. Pressureless exchangers would be destroyed by the counter-pressure.**

**This can lead to costly subsequent damages.**

Article	Description	Art. No.
FG 130	behropur® filter housing for 5" length filter inserts. Transparent housing made of PP. 3/4" nozzles, maximum operating pressure 8 bar, max. Temp. 50 °C	93 48 60260
FE 130	behropur® filter insert, PP, 5µ, 5" length, max. pressure 6 bar, max. Temp. 80 °C	93 48 60261
AF 130	behropur® filter insert, active charcoal, 20µ, 5" length, max. pressure 6 bar, max. Temp. 50 °C	93 48 60262
LS 191	behropur® leak protection set including control unit, water sensor, solenoid valve, alarm buzzer	93 48 50701

## Optimum Safety with behropur® Water Demineralisers

You are safety-conscious. Of course, you always shut the water supply when you are leaving your demineraliser unattended for a longer time.

But then, depending on the kind of application, water demineralisers sometimes have to work unattended. Sometimes it just can't be helped. But there are risks in it. So if you need to operate your behropur® water demineraliser unattended, you need the behropur® Leak Protection Set with a leak sensor.

If a leaky spot should form on your demineraliser, the tank will collect the water that is leaking out. The sensor will respond and shut off the water supply.

By this you are sure to avoid costly damages caused by water.

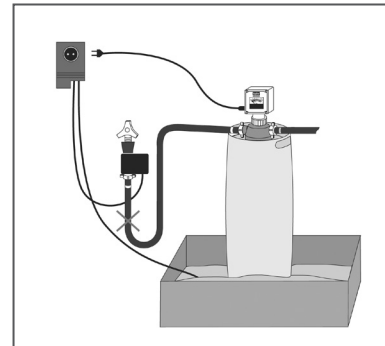
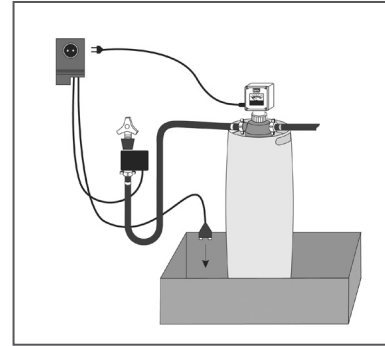

Use of the Leak Protection Set





behr Labor-Technik GmbH  
Spangerstraße 8 • 40599 Düsseldorf  
Tel.: (+49) (0) 211 – 7 48 47 17 • Fax: (+49) (0) 211 – 7 48 47 48  
eMail: [info@behr-labor.com](mailto:info@behr-labor.com) • Internet: [www.behr-labor.com](http://www.behr-labor.com)